



**A.E.A INTERNATIONAL  
(PVT.) LIMITED**

Company Profile



**Mechanical  
Services**



**Plumbing  
Services**



**Electrical  
Services**



**Renewable  
Energy**



Get in Touch

+92(02)134311985

Email: [info@aea.agc-green.com](mailto:info@aea.agc-green.com) - [aeai@yahoo.com](mailto:aeai@yahoo.com)

Website: [www.aea.agc-green.com](http://www.aea.agc-green.com)



# COMPANY INTRODUCTION



# **A.E.A INTERNATIONAL (PVT.) LIMITED**

## **PLANNERS & CONSULTING ENGINEERS**

### **OUR STORY**

Having extensive expertise in Engineering Electrical System Designing, a Group of Engineers working in different reputable organizations dreamed to establish their own Consultancy Firm for Electrical Engineering and Designing.

Their dream came true when they founded Advance Engineering as A Group of Associates in 1997, they realized their ambition. They worked really hard to get notoriety for their business on the basis of absolute professionalism.

### **OUR HISTORY**

Since the establishment of **Advance Engineering Associates**, their engineers, draftsmen, and supporting staff continued striving hard to bring the organization standing in the front-line consultancy firms. The dynamic combination of the latest concepts and technologies has been the secret to success.

As an electrical engineering consultant at first, AEA rapidly transitioned into MEP consulting. After gaining a sizable percentage of the local market share, AEA broadened its perspective, and in 2002 AEA got an opportunity to design and develop some projects for the international market, including Dubai Sharjah, and the UK.

Since AEA's business extended globally, we decided to convert AEA from an associated firm to a Private Limited organization. Additionally, as we offered MEP services internationally, we changed our name from AEA (Advance Engineering Associates) to **A.E.A International (Pvt.) Ltd.**

We are working with two renowned international companies, one based in the UAE and one in the United Kingdom.

We have a joint venture for MEP Designing in the UAE with:

#### **CONSULTAIR**

Engineers & Consultant

Electro-Mechanical Services

CONSULTAIR is a reputable name in MEP Service, working in the UAE for 40 Plus years, and has many mega Projects under their banner.

Our joint venture for Renewable Energy, in the UK, is with:

#### **HERTS RENEWABLE ENERGY SOLUTIONS LTD**

Herts Renewable Energy Solutions Ltd. has been working all over the UK. They have expertise in Solar Energy, Wind Turbines and in Microgrid System.



# A.E.A INTERNATIONAL (PVT.) LIMITED

## PLANNERS & CONSULTING ENGINEERS

Now, AEA is working under the Title of **A.E.A International (Pvt.) Ltd.**

Blending our experience with the above reputable organizations, M/s A.E.A International is proving ultimate expert solutions in the field of MEP and Renewable Energy Planning And Engineering.

### OUR MOTTO

Our motto is “**Engineering with Distinction**” It is not only meant as a sign of commitment to our honorable clients but also serves as a reminder to our staff that distinction comes from being innovative, and innovation combined with quality keeps you at the forefront of the pack.

As the need and capabilities of public and private sector to acquire, organize, maintain, and use of information and knowledge have grown and changed, AEA has effectively responded to the challenge and is committed to be at the leading edge of planning & design engineering.

The firm offers Consultancy Services in the fields of electrical and mechanical engineering renewable energy sources including solar energy & wind turbine to benefit industries like, textile, Pharmaceutical, cement, food ceramic and oil and gas installations, office buildings, hospitals, hotels, housing projects commercial centers, Laboratories, stadium and sports complexes.

A.E.A. International (Pvt.) Ltd., will assist you in your industrial development projects, in the preliminary study phase up to the commissioning of a product or installation, our teams of consultant engineers and experienced technicians will assist you effectively in all the reflection and conduct phases of your projects. Innovation, performance, reliability, fair cost and keeping to schedule are the guidelines A.E.A. International (Pvt.) Ltd., sticks to when carrying out projects entrusted to it, and they guarantee their success the advantage of proximity we mainly operate in PAKISTAN and in UAE, and when projects require it, we will assist you throughout the world. Our proximity, our constant adaptability and our market knowledge are major assets. A.E.A. International (Pvt.) Ltd., is a member of a group pf companies: we rely on our partners to offer you comprehensive and fully integrated solution.

The Firm also offers electrical safety audits and surveys that are suitable for a wide range of industries and technical competencies. Identifies the core hazardous issues and propose the recommendations as per survey. Due to high Energy crises and promoting of generating clean in Pakistan we also started work on Solar PV and Wind Energy sources.



# A.E.A INTERNATIONAL (PVT.) LIMITED

## PLANNERS & CONSULTING ENGINEERS

Promoting the success of your projects by associating it with our staff development, such is the challenge and desire of our company. A.E.A. International (Pvt.) Ltd., believe in providing a strong technical, professional and personal service which is underpinned by our enthusiasm to not only meet the Clients expectations, but to deliver a service that is recognized for its quality. We focus our dynamism and determination on the success of your projects, through the provision of our expertise and our outreach. To do this, we actively support our consultants in their success and their career development. As a company that is on a human scale, proactive and attentive to a market undergoing constant technological change, A.E.A. International (Pvt.) Ltd., offers innovative solutions and approved expertise, through its teams of consultants who are always motivated to take on ever-greater challenges. Aware that economic, human and environmental issues are decisive for the competitiveness of a business, we strive to listen to your requirements and analyze them in detail to build custom-made, tailored and efficient solutions.

Our employees are a human capital and a portfolio of expertise because of our team of consultants and managers; we have a capital of proven expertise, offering you solutions tailored to your needs. We strive to recruit our employees both for their technical skills in connection to the requirements of our client's projects and for their human qualities, in connection with our corporate values. A.E.A. International (Pvt.) Ltd., is a genuine human sized company, which gives us agility to respond to a market with changing requirements and a usability that promotes exchanges, emulation and the involvement of our employees. We put every effort into supporting them in their professional development within the company in order to meet their increase in competence and their development.



**A.E.A INTERNATIONAL (PVT.) LIMITED**  
**PLANNERS & CONSULTING ENGINEERS**

**PARTICUALRS OF FIRM**

Name: **A.E.A. International (Private) Limited**  
Reg. Off.: Suite # 313, 3<sup>rd</sup> Floor, Anum Estate, Shahra-e-Faisal,  
Karachi-Pakistan.  
Tel No. 021-34311985 & 021-34311986.  
Fax No. 021-34311987  
E-mail: ae.associates@yahoo.com, info@aea.agc-green.com  
Web Address: www.agc-green.com  
N.T.N. # 5412786  
Company: 0134025  
Year of Establishment: 10-May-2019

**U.A.E. OFFICES:**

**M/S. CONSULTAIR**

Engineers & Consultants Electro-Mechanical Services

**Sharjah**

P.O. Box 21656, Sharjah, U.A.E.  
Tel: +9716 561 2003  
Fax: +9716 561 2917  
e-mail: consair@emirates.net.ae

**Dubai**

P.O. Box 19404, Duabi, U.A.E.  
Tel: +9714 269 4404  
Fax: +9714 266 4303  
e-mail: consair@emirates.net.ae

**U.K OFFICE:**

**M/S. HERTS RENEWABLE ENERGY SOLUTIONS LTD.**

Censeo House, 6 St Peter's Street St  
Albans, Hertfordshire, AL1 3LF United Kingdom.  
Tel: +447583835629  
Email: faizan@hrenergysolutions.co.uk  
Company No: 9493679  
EORI NO.: GB216791104000



# SCOPE OF SERVICES



# A.E.A INTERNATIONAL (PVT.) LIMITED

## PLANNERS & CONSULTING ENGINEERS

### **SCOPE OF SERVICES**

The scope of services offered by the organization is hereunder:

- Survey and Analysis of electrical installations.
- Preparation of schematic and working drawings fully reflecting intent and spirit of design, specification of materials and workmanship. Bill of Quantities and construction documents.
- Working out distribution network, sizes of feeders and sub-mains, system protection scheme, rating and configuration of transformer, power factor improvements plants, HT and LT switchgear.
- Designing of illumination schemes including emergency, exterior, and streetlights based on standards prescribed by Illumination Engineers Society (IES).
- Compute total electrical load requirements of the project. Process load to be furnished by owners, air-conditioning and pumps load by mechanical consulting engineers, lighting load to be computed at this end.
- Planning for special system like germicidal lighting for hospitals, and food storage, telephone, intercom, bank security T.V., electric clocks, fire alarm or any other specially called for requirements.
- Discuss with supply companies the available voltage and tariff structure for the computed load requirements.
- Prepare engineering cost estimates with (+-) 10% accuracy.
- Determine most suitable and economical location of sub-station or generating station.
- Scrutiny of tenders, comparative studies, and recommendations for award of contract.
- Supervision of electrification work, verification of contractor bills and preparation of As-installed drawings.
- Coordination of electrical services with process equipment, Water supply, sanitary and HVAC systems.

\*\*\*\*\*



# **A.E.A INTERNATIONAL (PVT.) LIMITED**

## **PLANNERS & CONSULTING ENGINEERS**

### **\* ELECTRICAL ENGINEERING SERVICES**

#### **❖ Light and power distribution:**

- a) Internal And External Lighting
- b) Street Lighting
- c) Flood Lighting
- d) Illumination
- e) Power Distribution System

#### **❖ Power House / Substation Design:**

- a) Generator
- b) Transformer
- c) L.V. Panel
- d) M.V. Panel
- e) ATS / AMF Panels
- f) Cable Trays

#### **❖ E.L.V. System / IT & Security System:**

- a) Tele-Communication System
- b) Ups For Computer Network
- c) Fire Alarm System
- d) Closed Circuit Television (C.C.TV)
- e) Paging System
- f) Access Control System
- g) Vehicle Identification System
- h) Parking Management System
- i) Infrastructure for Fiber Optical Cable
- j) Data Centre Designing (if required)



**A.E.A INTERNATIONAL (PVT.) LIMITED**  
**PLANNERS & CONSULTING ENGINEERS**

❖ **Load Management System:**

- a) Metering Management System
- b) Building Management System
- c) Central Battery System

❖ **Protection System:**

- a) Earthing System
- b) Lightning Protection System

❖ **Alternate Energy System:**

- a) Solar Energy System
- b) Wind Energy System

\* **CODES AND STANDARDS:**

- ❖ British Standards (BS)
- ❖ IEEE Regulations (16<sup>th</sup> Regulation)
- ❖ National Electric Codes (NEC)
- ❖ National Fire Protection Association Standards (NFPA) (latest edition)
- ❖ American National Standards Institute Standards (ANSI)

\*\*\*\*\*



# A.E.A INTERNATIONAL (PVT.) LIMITED

## PLANNERS & CONSULTING ENGINEERS

### **ELECTRICAL SAFETY SURVEY:**

- ❖ Make in-depth analysis of the system in respect of safety of life and property as well as suitability to continue use.
- ❖ Update As-installed electrical drawing accurately reflecting complete electrical installation in plan and schematic.
- ❖ Calculate minimum, average and peak consumption over single and three phases and provide a fully detailed report using graph and timed detail format, making the readings very easy to understand.
- ❖ Check the balance of phases to make sure that there are no underlying problems.
- ❖ Prepare detailed report based on findings and propose modification / alterations, consistence with engineering code requirements and in line with good engineering practices.
- ❖ Prepare time schedule for Finalization of rectification proposals making ongoing functions undisturbed.

### **CO-GENERATION SYSTEMS DESIGNS & SUPERVISION:**

- ❖ Study, Examination & preparation of feasibility reports for Co-Generation.
- ❖ Preparation of conceptual location as per load center.
- ❖ Preparation of detailed Flow Diagram.
- ❖ Preparation of ISO-Metric Diagram Sharing Machinery Position.
- ❖ Preparation of detailed BOQ, Technical Specs and all Mechanical & Civil Diagram.
- ❖ Top line Supervision.



# A.E.A INTERNATIONAL (PVT.) LIMITED

## PLANNERS & CONSULTING ENGINEERS

### **PLUMBING & OTHERS SERVICES:**

- ❖ Pumping and Piping Distribution
- ❖ Soil, Waste and Vent Piping
- ❖ Water Supply
- ❖ Disposal of Sewage and Storm Water
- ❖ Central Hot Water Generation and Supply
- ❖ Water Treatment
- ❖ Sewage Treatment Plant

### **MECHANICAL ENGINEERING SERVICES:**

- ❖ Heat Ventilation and Air Conditioning
- ❖ Fire Fighting System
- ❖ Industrial Environment Control
- ❖ Heat Recovery System

### **CODES AND STANDARDS:**

- ❖ Air Conditioning and Refrigeration Institute Standards (ARI)
- ❖ American Society of Mechanical Engineers Code (ASME)
- ❖ National Fire Protection Association Standards (NFPA) (latest edition)
- ❖ American National Standards Institute Standards (ANSI)

### **HVAC**

- ❖ Heating
- ❖ Mechanical Ventilation and Industrial Ventilation
- ❖ Air Conditioning
- ❖ Central Evaporative Cooling
- ❖ Refrigeration System



**A.E.A INTERNATIONAL (PVT.) LIMITED**  
**PLANNERS & CONSULTING ENGINEERS**

**FIRE FIGHTING SYSTEM**

- ❖ Fire Protection & Fire Fighting Pumping System
- ❖ Fire Extinguisher Installation
- ❖ Fire Hydrant System
- ❖ Sprinkler System
- ❖ Gas based Installation.

**INDUSTRIAL ENVIRONMENT CONTROL**

- ❖ Building Automation System
- ❖ Fire Detection & Alarm System
- ❖ Public Address System
- ❖ Access Control
- ❖ Close Circuit Television
- ❖ Security System



# A.E.A INTERNATIONAL (PVT.) LIMITED

## PLANNERS & CONSULTING ENGINEERS

### **SOLAR PV SYSTEM**

- a) Large Scale on grid solar PV designs with Drawings, BOQ and Providing testing reports after commissioning (for Utility and self-power generation projects)
- b) Commercial, domestic, and Industrial On Grid Solutions with design, BOQ drawings and providing testing result after commissioning.
- c) Designs, drawings and BOQ with battery calculations for off grid and on grid with battery back-up (Self Consumption and grid failure) solar PV systems.
- d) Large Scale Solar PV Hybrid Solutions (Solar PV, Grid and Generators) for commercial and industries.
- e) Solar PV Rectification Testing and Commissioning, also providing STC (Standard test condition) results.
- f) Feasibility reports for Solar PV Energy Generation solutions for your home, business, high-rise tower, commercial, housing societies and Industries.
- g) Real-Time Monitoring System for Solar Plants.
- h) Design of Infrastructure for Electric Vehicle Chargers in Domestic and Commercial Environments.
- i) Requirements for Isolation and Switching of the D.C and A.C Sections.
- j) Designs of Solar Street Lighting.
- k) Solar Water Pumping System design.
- l) Single Line Diagram.
- m) Health and Safety Requirements.
- n) Consumer Protection and Guidance.
- o) AC Combiner General Arrangement Diagram.
- p) DC String Wiring Diagram.
- q) Earthing & Lighting Arresters Layout
- r) Cable Routing and Schedule Layout.



**A.E.A INTERNATIONAL (PVT.) LIMITED**  
**PLANNERS & CONSULTING ENGINEERS**

❖ **CODES AND STANDARDS:**

- British Standards (BS7671 17<sup>th</sup> Edition)
- IEEE Regulations (16<sup>th</sup> Regulation)
- National Electric Codes (NEC)
- Level 3 Award in the Installation, Commission and Maintenance of Solar PV 9UK)
- Level 3 Award in the Requirements for Electrical Installation BS 7671 (UK)
- National Fire Protection Association Standards (NFPA) (latest edition)
- American National Standards Institute Standards (ANSI)

\*\*\*\*\*



**COMPANY REGISTRATION  
CERTIFICATE**



A054363

SECURITIES AND EXCHANGE COMMISSION OF PAKISTAN

COMPANY REGISTRATION OFFICE, KARACHI

CERTIFICATE OF INCORPORATION

[Under section 16 of the Companies Act, 2017 (XIX of 2017)]

Corporate Universal Identification No. 0134025

I hereby certify that A.E.A. INTERNATIONAL (PRIVATE) LIMITED is this day incorporated under the Companies Act, 2017 (XIX of 2017) and that the company is limited by shares.

Given under my hand at Karachi this Tenth day of May, Two Thousand and Nineteen

Incorporation fee Rs. 1,000/=

  
(Muhammad Naeem Khan)  
Additional Registrar/Incharge CRO





**NATIONAL INCOME TAX  
CERTIFICATE**

## **TAXPAYER REGISTRATION CERTIFICATE**

(Under Section 181C of the Income Tax Ordinance 2001)

**Registration No.** 5412786



5412786

**Date of Registration** 10-May-2019

**Type of Person** Company

**Inc. No.** 0134025

**Inc. Date** 10-May-2019

**Name** A.E.A. INTERNATIONAL (PRIVATE) LIMITED

**Address** 313, ANUM ESTATE, SHAHRAH-E-FAISAL, Pakistan

**Tax Office** RTO (CORPORATE) KARACHI

**Activity Type** Business

Inland Revenue Service

This is a computer generated certificate and,  
hence, no signatures are required.

Displaying of Taxpayer Registration Certificate is mandatory as  
provided under section 181C of Income Tax Ordinance 2001

This is not a valid evidence of being a "filer" for the purposes of clauses (23A) and (35C)  
of sections 2 and 181A of the Income Tax Ordinance 2001.



# **Pakistan Engineering Council Certificate**

# PAKISTAN ENGINEERING COUNCIL

Registration No: **CONSULT/2326**

Date of Registration: **30-05-2022**



Serial No **16541**  
PEC-4A

## CERTIFICATE OF REGISTRATION OF PAKISTANI CONSULTING ENGINEER

(UNDER PAKISTAN ENGINEERING COUNCIL ACT 1976)

This is to certify that M/s **A.E.A INTERNATIONAL (PVT) LTD** Address **SUITE # 313, 3rd FLOOR, ANUM ESTATE, SHAHRA-E-FAISAL, KARACHI** have been registered as Consulting Engineers at Serial No **CONSULT/2326** of the Register of Pakistan Engineering Council with following particulars:-

Type of Ownership (021,022,023,024) **(PRIVATE LIMITED COMPANY)**

Field of Specialization

(Project-profile Code Nos.) **1208(ii),1210,1220,1234(iii)(FOUR ONLY)**  
**(FOR ELECT ENGG WORKS ONLY)**

Date of Issue:  
**02/07/2025**



Registrar  
Pakistan Engineering Council,  
Islamabad.

### Note:

1. This Certificate of Registration shall expire on **30th June 2026** and will be renewed on payment of the required fee before **31st July, 2026**.
2. Description of project profile codes is shown on reverse.

**ISO Certificate**



# Certification

Awarded to

**A.E.A. INTERNATIONAL (PRIVATE) LIMITED**

Head Office

Suite # 313, 3rd Floor, Anum Estate, Shahrah-e-Faisal, Karachi - Pakistan.

Reliable Certification Ltd. certifies that the quality management system of the above organisation has been audited and found to be in accordance with the requirements of the management standard detailed below

Standard

**ISO 9001:2015**  
**QUALITY MANAGEMENT SYSTEM**

Scope of Certification

Consultancy Services for MEP Work in Highrise Building Projects and in Commercial & Industrial Sector, Power Transmission & Distribution Networks, Renewable Energy Sources & System, Energy Planning, Conservation & Development, Electrical Energy & Safety Audit.

Certificate number: RCLQ100936  
Initial Certification date: 07-NOV-2024  
Recertification date: 06-NOV-2027

Subject to the continued satisfactory operation of the organization's management system

Director



Certification Body: RELIABLE CERTIFICATION LTD.  
Address: 412 Allied Sainif House Greenford Rd, London UB6 9AH.  
For further information, please contact [info@reliablecert.uk](mailto:info@reliablecert.uk)  
To check the validity of this certificate, please visit: [www.reliablecert.uk](http://www.reliablecert.uk)  
Accreditation by UNITED KINGDOM INTERNATIONAL CERTIFYING BOARD (UKICB)  
Address: 4 The Ridgeway, Ridgeway Trading Estate, Iver, England, SLO 9HW.  
For further clarification regarding accreditation, please visit [www.ukicb.co.uk](http://www.ukicb.co.uk)



# Certification

Awarded to

**A.E.A. INTERNATIONAL (PRIVATE) LIMITED**

Head Office

Suite # 313, 3rd Floor, Anum Estate, Shahrah-e-Faisal, Karachi - Pakistan.

Reliable Certification Ltd. certifies that the environmental management system of the above organisation has been audited and found to be in accordance with the requirements of the management standard detailed below

Standard

**ISO 14001:2015**  
**ENVIRONMENTAL MANAGEMENT SYSTEM**

Scope of Certification

Consultancy Services for MEP Work in Highrise Building Projects and in Commercial & Industrial Sector, Power Transmission & Distribution Networks, Renewable Energy Sources & System, Energy Planning, Conservation & Development, Electrical Energy & Safety Audit.

Certificate number: RCLQ100937  
Initial Certification date: 07-NOV-2024  
Recertification date: 06-NOV-2027

Subject to the continued satisfactory operation of the organization's management system

Director



Certification Body: RELIABLE CERTIFICATION LTD.  
Address: 412 Allied Sainif House Greenford Rd, London UB6 9AH.  
For further information, please contact [info@reliablecert.uk](mailto:info@reliablecert.uk)  
To check the validity of this certificate, please visit: [www.reliablecert.uk](http://www.reliablecert.uk)  
Accreditation by UNITED KINGDOM INTERNATIONAL CERTIFYING BOARD (UKICB)  
Address: 4 The Ridgeway, Ridgeway Trading Estate, Iver, England, SLO 9HW.  
For further clarification regarding accreditation, please visit [www.ukicb.co.uk](http://www.ukicb.co.uk)



# Certification

Awarded to

**A.E.A. INTERNATIONAL (PRIVATE) LIMITED**

Head Office

Suite # 313, 3rd Floor, Anum Estate, Shahrah-e-Faisal, Karachi - Pakistan.

Reliable Certification Ltd. certifies that the health and safety management system of the above organisation has been audited and found to be in accordance with the requirements of the management standard detailed below

Standard

**ISO 45001:2018**

**HEALTH AND SAFETY MANAGEMENT SYSTEM**

Scope of Certification

Consultancy Services for MEP Work in Highrise Building Projects and in Commercial & Industrial Sector, Power Transmission & Distribution Networks, Renewable Energy Sources & System, Energy Planning, Conservation & Development, Electrical Energy & Safety Audit.

Certificate number: RCLQ100938  
Initial Certification date: 07-NOV-2024  
Recertification date: 06-NOV-2027

Subject to the continued satisfactory operation of the organization's management system

Director



Certification Body: RELIABLE CERTIFICATION LTD.  
Address: 412 Allied Sainif House Greenford Rd, London UB6 9AH.  
For further information, please contact [info@reliablecert.uk](mailto:info@reliablecert.uk)  
To check the validity of this certificate, please visit: [www.reliablecert.uk](http://www.reliablecert.uk)  
Accreditation by UNITED KINGDOM INTERNATIONAL CERTIFYING BOARD (UKICB)  
Address: 4 The Ridgeway, Ridgeway Trading Estate, Iver, England, SLO 9HW.  
For further clarification regarding accreditation, please visit [www.ukicb.co.uk](http://www.ukicb.co.uk)





## ETAP AUTHORIZATION LETTER



**ARSON**  
Engineering

## TO WHOM IT MAY CONCERN

**Subject: Authorization for the usage of ETAP Software In K.Electric for the year 2023.**

***Dated: 01<sup>st</sup> Of January, 2023***

Dear Sir,

Arson Engineering is authorized reseller and system integrator of ETAP in Pakistan. Also we have licensed ETAP Software through which we are engaged in executing Power System Studies.

We hereby confirm that M/s. A.E.A International shall utilize our Engineering expertise on Arson's licensed ETAP Software to perform Load Flow study cases on ETAP as per K.E requirements.

In this regards, M/s. Arson Engineering will be providing complete support to M/s. A.E.A International for client satisfaction and successful execution of Projects.

This authorization is valid till December 2023.

Regards,

  
Muhammad Kashif  
Manager Sales & Marketing  
Arson Engineering



# **BANK ACCOUNT MAINTENANCE CERTIFICATES**



Date: 20-12-2022

ACCOUNT MAINTENANCE CERTIFICATE

This is to certify that we are maintaining HBL CURRENT ACCOUNT No. 24437901538103 since 26 SEP 2022. The Account is being maintained with the following details:

1. Title of Account	<u>A.E.A. INTERNATIONAL (PRIVATE) LTD</u>
2. IBAN	<u>PK78 HABB 0024 4379 0153 8103</u>
3. Bank & Branch Name	<u>HBL SHAHRAH E FAISAL BRANCH (2443)</u>
4. Status of Account	<u>ACTIVE</u>
5. Nature of Account	<u>PRIVATE LTD CO (PRIVATE NATIONA COMPANY)</u>
6. Name & CNIC	<u>SUHAIB UL MUKHTAR / 4220186141193</u> <u>FAIZAN ALI KHAN / 4220182565017</u> <u>RAKSHAN ALI KHAN / 4220108580349</u>

This Certificate is issued upon the written request of the customer without any risk and responsibility on the part of the Bank.

Sincerely,

Branch Officer

**HBL SHAHRAH-E-FAISAL BR.**  
Prestige  
KHI (2443)

Branch Operations Manager/Branch Manager

Habib Bank Limited  
Branch Name: HBL Shahrah-e-Faisal Branch (2443)  
Address: 1-3 Ibrahim Trade Tower Shahrah-e-Faisal  
Karachi  
Tel: +92-21-34327642 & 34327646



# ORGANIZATION CHART

# Organization Chart

Thursday, June 03, 2010

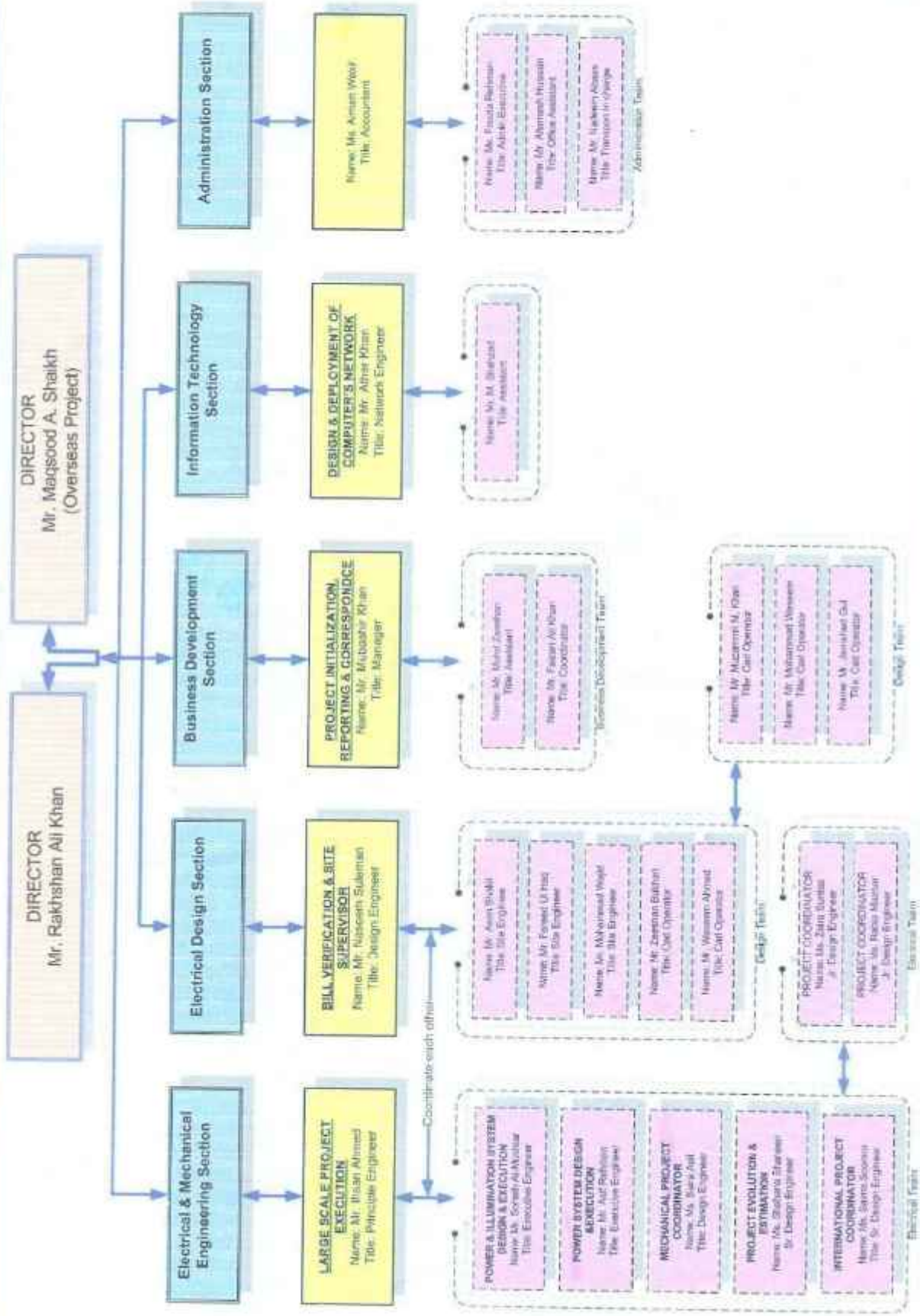



## THE CHAIRMAN



# A.E.A INTERNATIONAL (PVT.) LIMITED

## PLANNERS & CONSULTING ENGINEERS

### **Rakhshan Ali Khan**

(Chairman)

Rakhshan Ali Khan is a graduate in Electrical Technology from N.E.D University of Engineering and Technology; He is a very ambitious person. Besides graduation he has done many additional courses which include:

- Course in Computer Engineering at PETROMAN Karachi.
- Course in Electric Power Generation at CATERPILLAR (overseas)
- Course in Energy Conservation at ENERCON Karachi.

Serving as a Principal of AEA he has over twenty-five years of experience in design conception, detailed designing and top supervision of small medium and large electrical installation in different firms of repute.

In 1982 he joined WJ. Associates as Design Engineer, there he was engaged in the designing of several projects.

In 1986 he joined Consumer Electric Corporation as Project Engineer, to gain experience on site.

After three years in 1989, he again joined WJ. Associates to master his natural skills in designing.

His dynamic and progressive nature never let him stay at one point so he decided to form his own independent Consultancy firm in the name and style;

### **Advance Engineering Associates**

Electrical & Mechanical Consultancy Engineers

Suite # 313, 3<sup>rd</sup> Floor, Anum Estate,

Shahrah-e-Faisal, Karachi.



# A.E.A INTERNATIONAL (PVT.) LIMITED

## PLANNERS & CONSULTING ENGINEERS

During his Services in WJ Associates & Consumer Electric Corporation Rakhshan Ali Khan surveyed, analyzed, planed and designed many projects, details of which appear on following pages.

### ✓ INDUSTRIAL UNITS

1. Boots Pharmaceuticals Pakistan Ltd.  
Expansion 82
2. Searle Pakistan Limited.  
New Manufacturing Facility  
Architect: Thariani & Co.
3. Continental Biscuits Limited.  
S.I.T.E., Sukkur.
4. Gelcaps Pakistan Limited.  
L.I.E.D.A. Hub Chowki.
5. Shabbir Textiles & Ceramic Ltd.  
Landhi, Karachi  
Expansion 85.
6. Lube Oil Building Plant.  
At: L.I.E.D.A.  
Hub Chowki.
7. Habib Oil Mills.  
S.I.T.E. Karachi.  
Expansion of Refinery.
8. Rooh Afza Plant, Karachi.  
Consultants:  
Team Consultants.



# A.E.A INTERNATIONAL (PVT.) LIMITED

## PLANNERS & CONSULTING ENGINEERS

9. CNG Station-Nister Road, Karachi.
10. Saqib Industries-Refurbishment of Electrical System.
11. Continental Biscuits Ltd., Sukkur. (Expansion-94)

✓ **OFFICE BUILDING**

1. Karachi Dock Labour Board Building  
West Wharf Road, Karachi.  
Architect: Bilgrami & Faruque
2. Office Building-KPT Workers.  
Architect: Bilgrami & Faruque
3. Office Building-For BCCI at Bauch, Nigeria.  
Architect: Saleem Ahmed Associates.
4. New Office Block-Smith & Nephew, S.I.T.E. Karachi.  
Architect: Thariani & Co.
5. Searle Head Office-In KDLB Building  
Architect: Thariani & Co.
6. State Life Building at Sukkur  
Architect: Sikandar Ajam Associates.
7. BCCI Foundation House  
Architect: Saleem Ahmed Associates.
8. Council of Islamic Ideology Building Islamabad.  
Architect: Sikandar Ajam Associates.
9. National Bank of Pakistan-Quetta.  
Architect: M.A. Farooque & Co.



# **A.E.A INTERNATIONAL (PVT.) LIMITED**

## **PLANNERS & CONSULTING ENGINEERS**

### ✓ **SPORTS COMPLEXES & MONUMENTS**

1. Refurbishment of Malam Jabba
2. Re-Design of Band Shell  
Karachi American School  
Architect: Nasir Lotia

### ✓ **HOTELS & HOSPITALS**

1. Hotel Midway House  
Karachi Airport.  
Expansion 85
2. Lady Dufferin Hospital Karachi.  
New Operation Theater Block  
Architect: Refique & Naveed.
3. Shifa International Hospital Ltd.  
Islamabad.

### ✓ **EMERGENCY POWER SUPPLY**

1. Hotel Midway House Ltd., Karachi Airport.  
(2-500 KVA)
2. Abbott Laboratories Pakistan Ltd  
Landhi, Karachi.  
(2-285 KVA) Gas Generators.
3. Continental Biscuits limited-Sukkur.  
(1-350 KVA)
4. Shifa International Hospital-Islamabad.  
(1-750 KVA)
5. Continental Biscuits limited,  
Sukkur,  
(1-500KVA)



# A.E.A INTERNATIONAL (PVT.) LIMITED

## PLANNERS & CONSULTING ENGINEERS

6. Habib Oil Mills (Pvt.) Ltd-S.I.T.E. Karachi  
(1-350 KVA)
7. Sind Club-Karachi.  
(1-125 KVA).
8. Shifa International Hospitals Ltd-Islamabad.  
(1-1000 KVA)
9. 1.1 MW Co-Generation Plant,  
Abbott Laboratories (Pakistan) Ltd-Landhi Karachi.  
Principal Consultant: Ain-ul-Abedin.
10. Neunehal Plant.  
Hamdard Lab. (Wafq) Pakistan,  
Hamdard Industrial Town, at Deh Halkani,  
Team Consultants (Pvt) Ltd.

✓ **Survey And Analysis of Electrical System**

1. Marriot Hotel, Karachi
2. Shell Pakistan Limited, Karachi
3. Continental Biscuit Limited, Karachi
4. Habib Bank Plaza, Karachi
5. Hamid Flour Mills Limited, Sukkur
6. Al-Murtaza Machinery Company, Karachi
7. Brooke Bond Pakistan Limited, Karachi
8. Defence Housing Authority Office, Karachi
9. Tapal Tea (Pvt) Limited, Hub Chowki
10. Parke Davis & Company Ltd
11. Pakistan Cables Limited, Karachi
12. SK & F Pakistan Limited, S.I.T.E., Karachi
13. Rakaposhi Inn, Gilgit
14. Sawat Hotel, Sawat
15. Karachi Feeds Limited, Karachi Berger Paints Pakistan Limited, Karachi
16. Smith & Nephew Pakistan Limited, Karachi



# A.E.A INTERNATIONAL (PVT.) LIMITED

## PLANNERS & CONSULTING ENGINEERS

### ✓ List Of Solar PV Projects

1. 110KW On-Grid Solar PV Installation at Prologis Park, Hayes London UK.
2. 120KW On-Grid Solar PV Installation at Artistic Denim Mills (ADM), Karachi, Pakistan.
3. 3KW On-Grid Solar PV system with Battery Back-Up of 7.2 KWh, at Gulshan-E-Maymar, Karachi, Pakistan.
4. 2.4KW On-Grid Solar PV Installation at P.E.C.H.S, Block-2, Karachi, Pakistan.
5. 2.7KW On-Grid Solar PV for House at Luton, Bedfordshire, UK.
6. On-Grid 5KW at Gold Palace at Saddar, Karachi.
7. On-Grid 304KW at Philip Morris Pakistan factory at Sahiwal, Pakistan.
8. On-Grid 60KW Clariant Pakistan Limited.

### ✓ Design And Feasibility Stage

1. Artistic Denim Mills (ADM) 1.2MW.
2. Artistic Garments 130KW.
3. Nueplex Askari 150KW.
4. Artistic K-15 330KW.
5. Soorty Mills 600KW.
6. Siemens 100KW.
7. US Denim Lahore Pakistan 1.5MW.
8. Continental Biscuits Limited (CBL) 1.3MW.



## ASSOCIATES



# A.E.A INTERNATIONAL (PVT.) LIMITED

## PLANNERS & CONSULTING ENGINEERS

### **SUHAIB UL MUKHTAR- C.E.O, Director Technical**

Graduated in Electrical Engineering in 1992. Registered as Professional Engineer in Pakistan Engineering Council.

During his 30 + working experience, he has served various organizations in Pakistan and abroad. In Pakistan, he has served:

- Karachi Electric Supply Corporation (Presently known as K.E Pvt. Ltd.)
- Gatron Industries Ltd.
- Parke Davis Pharma (Presently known as Pfizer Inc.)
- Advance Engineering Associates

He has also worked in the Kingdom of Saudi Arabia for more than 15 years on various Residential, Commercial, and Industrial Projects for:

- Saudi Royal Commission for Jubail and Yanbu
- Saudi Ministry of Defense
- Saudi Electric Company
- Saudi Ministry of Youth and Sports Affairs
- His experience includes:
- Project Management
- Designing and Execution of LV, MV Power Distribution system, Unit Sub-stations, Residential Colonies, High Rise Residential and Commercial Complex Projects in Pakistan, Saudi Arabia and UAE.

He has completed a number of Training Programs conducted by renowned local and foreign companies in Electrical Power Generation, Electrical safety Measures at site, Officers Management, Stress Handling at Work Place etc.

Working with Advance Engineering his key projects are:

- Power Upgradation Project for Shell Pakistan Ltd.
- Expansion of Abbott Laboratories Pakistan
- Expansion of Parke Davis Pharma
- High rise Residential and Commercial Projects

---

#### **Certificates & Affiliations:**

Pakistan Engineering Council P.E (Elect/13683)

- Saudi Council of Engineers
- Institute of Integrated Electrical Engineers
- Junior Chamber International -USA (Pakistan Chapter)

\*\*\*\*\*



# A.E.A INTERNATIONAL (PVT.) LIMITED

## PLANNERS & CONSULTING ENGINEERS

### **FAIZAN ALI KHAN – Director Business Development**

Graduated as B.E (Hons) Electrical & Electronic Engineering in 2014 from University of Hertfordshire- UK

He is responsible to take care of local projects in Pakistan and international projects in the UK.

After graduation he started working in the United Kingdom with Herts Renewable Energy Solutions LTD- His key responsibilities there included:

- Solar PV system design, drawings, system output calculations, system synchronization with grid and complete site supervision before and after the complete installations.
- Testing, commissioning and handover of Solar PV systems On-Grid, On-grid with back up and Off-Grid systems.
- Design, Calculations, making of BOQ (Bill of Quantities) with drawing (Single line drawing or Shop drawing on CAD) for on-Grid, on-Grid with back up and off-Grid solar PV systems.
- Getting regular updates from suppliers and manufactures for new products and accreditations in the Solar Industry globally.
- Selecting the right products depending on geographical location and customer demands.
- Analyse equipment and machine failures and suggest effective solutions.
- Ordering all Equipment from suppliers and maintain log book of costs and hours allocated to various activities performed on site throughout the project execution and testing.
- Understanding of reactive maintenance and preventive maintenance for Solar PV projects (O&M operations).
- Generating Complete required service reports and documentation for different activities completed on site.
- Supporting the development of the operations and maintenance services.
- Responsible for schedule for each plant completing required works with in the given deadlines.

Since 2019, he has joined A.E.A International (Pvt.) Ltd. As Director Designing. In AEA International his role includes:

- Detailed Engineering of project design in Pakistan and the UK.
- Preliminary Design and cost estimation for the bid preparation.
- Technical evaluation of tenders, detail engineering and design.
- Top supervision of ongoing project and planning for QA/QC supervision works.
- Preparation of the technical documents for the bidding process.
- Preparing daily workloads for staff & co-ordinating the daily allocation of work.
- Motivating the team to achieve high standards and AEA targets.
- Handling present and new client's enquiries and acting as the face of the business.
- Dealing with and resolving problems and issues, which arise.
- Arranging & chairing weekly team meetings, focusing on targets and achievements.



# A.E.A INTERNATIONAL (PVT.) LIMITED

## PLANNERS & CONSULTING ENGINEERS

In addition, he has good working knowledge and experience in the field of Power, Communication and Control System, such as:

- Microelectronics and VLSI
- Intelligent Systems and Robotics
- Digital Signal Processing
- Digital Design and Embedded Systems
- Real-time Systems and Programming
- Digital Electronics and Computer Organisation
- Data Acquisition and Control Systems
- Electronic Engineering Practice

---

### Certificates & Affiliations:

- Pakistan Engineering Council | **ELECT / 72286**
- Level 3 Award in the Installation, Commission and Maintenance of Solar PV (UK).
- Level 3 Award in the Requirements for Electrical Installation BS 7671 (UK).
- Solar PV Industry Certificates and training with SMA, Victron Energy, Tesla and LG Chem.
- Solar PV Software: Sunnydesign, Sunnyportal, PVsol, Victron Energy and HelioScope.
  
- **Programming Languages:** C, Visual C++, C#, VHDL, Assembly, Ladder Logic programming and STL programming.
- **Development Tools:** Matlab, Simulink, Altium Designer, VisualDSP ++ V5.0, Auto CAD, Dilux, Microsoft Visual Studio, Tina Pro7, PCB design.

\*\*\*\*\*



# A.E.A INTERNATIONAL (PVT.) LIMITED

## PLANNERS & CONSULTING ENGINEERS

**ENGR. MOHAMMAD IHSAN AHMED**  
**B.E (Electrical)**

Engr. M Ihsan graduated from NED University of engineering and technology Karachi in 1975. He received one year training from Karachi electric supply corporation on their steam power station at Korangi creek and West wharf, served KESC for almost 2 years as operation engineer.

In 1979 he left for M/S Saudi consolidated electric company, Riyadh and worked in gas turbine power and got vast experience in startup, commissioning, operation and maintenance of 12x50MW crude oil-fired gas turbine power station, 132KV transmissions system, fuel management, black start diesel generator and all accessories of the same power station.

He came back to Pakistan in 1990 and join M/S Fulbrite international agencies and worked in sales of power plant spares and supplied to KESC and WAPDA.

He joined UCL (United Carpet Ltd) having x-minister looms of carpet, scouring, and spinning sections, full/semi-automatic machines, and electrical distribution system, control and protective devices.

He left again for M/S Saudi electric company, Riyadh in same capacity and same power stations as in 1979 and served for 5 more years from 1994.

He joined M/S General Electric company Saudi Arabia who were working in erecting new combined cycle power station of 1344mw having 16 gas turbines of 57MW each and 4 steam turbines of 108MW each, 380kv transmission system, gas turbine were multi fuel fired. He worked as lead start up and commissioning engineer.

He joined Friendship Textile Mill site in 2001 as Manager Utilities and Maintenance. He erected gas turbine (Kawasaki GP 1500, 1500KVA) with waste heat recovery boiler of 4.75 tons. He was involved in installation, erection, commissioning, test run a commercial operation, spare parts management of gas turbine, waste heat recovery boiler and 11KV transmission system.

From December 2002 he is working with Advance Engineering Associates in the capacity of electrical designed engineer and responsible for system design, and planning supervision for industrial projects.

\*\*\*\*\*



# A.E.A INTERNATIONAL (PVT.) LIMITED

## PLANNERS & CONSULTING ENGINEERS

### SYED MOHAMMAD TAJUDDIN B.E.(Electrical)

Engr. Syed Tajuddin graduated from N.E.D Engineering College in 1973. After working with a local trade and construction company, left for Saudia Arabia in 1975, and worked for sixteen years with M\s. Rajab and Silsilah Co. one of the largest companies with interest in trading, construction and manufacturing. Work in different projects from traffic signals, local area power distribution networks and substation electrical equipment installation and commissioning, tendering and in low current projects of CCTV, Fire alarms system and baggage screening systems. During the period promoted from site engineer to area incharge.

In the year 1992 joined the sales department of Al-Qureshi Electrical the sales and marketing company for the T & D products of Westinghouse USA and also WESCOSA the sister company manufacturing M.V., L.V. Switchgear and up to 3000KVA distribution transformers.

In the year 1997, he came to Pakistan and joined Johnson & Philips Co. as Sales Manager and later as Manager Projects in their project department.

In the year 2001 joined the Jubilee Corporation as senior sales engineer. Jubilee Corporation is the sole representative of Fifty different low voltage power and control products of known European, Japanese and Korean companies.

After brief tenure with M/s Matrix Consultant joined the Aisha Steel Mills in 2010 and worked up to 2013 as Senior Manager Electrical during the construction of the factory. Aisha steel mills is the cold roll mills of steel and it is the joint venture between Arif Habib group and Japanese group.

Mr.Tajuddin has unique experience of working in all the three branches of engineering which is construction, sales and design and have good knowledge international standard and practice.

\*\*\*\*\*



# A.E.A INTERNATIONAL (PVT.) LIMITED

## PLANNERS & CONSULTING ENGINEERS

### **ENGR FAHAD ISLAM**

**B.E.(Electronics), M.Engg. (Electrical), M.B.A**

Mr. Fahad Islam graduated from N.E.D University of Engineering and Technology, Karachi, in 2003. He completed MBA in 2006 and M.Engg in 2009. Beside this, and he has also done different Electrical, Automation and Computer courses.

Since starting his career in 2004, he worked with Siemens Pakistan Engineering Co., Areva T & D Pakistan and Saudi Services for Electro-Mechanic Works Co. (Saudi Arabia) on various projects of Power plants, Processing plants, Grid stations, large scale industrial units and utility sectors.

He has hands on working experience in the field of High, Medium, Low voltages, Instrumentation, Automation, Controlling, Electrical system designing and building Management Systems. Moreover, he has also been Providing leading role for erection, installation, testing, commissioning, preparation of BOQs, Tenders, Budgeting, Cost estimates, Business development and Project Management.

He joined Advance Engineering Associates in 2013 and working as a Manager (Business Development).

\*\*\*\*\*



# A.E.A INTERNATIONAL (PVT.) LIMITED

## PLANNERS & CONSULTING ENGINEERS

### **ENGR. SHAHANA SHAHEEN**

#### **B.E.(Electrical)**

Engr. Shahana Shaheen has passed her B.E. Electrical in 1<sup>st</sup> division in the year 2004, from N.E.D. University of Engineering and Technology Karachi. A brilliant student with an excellent academic record. Her final year project was "Scrambling & Sescrambling of Voice Data."

She is very desperate in doing project with new technology and challenges. She has done a project based on light Emitting Diode (LED) for Habib Bank Plaza. LED lighting scheme is applied for the first time in Pakistan.

She is responsible to prepare Consultancy Service Proposals, Recommendation Letters, Bill of Quantities, Cost Estimation, Comparative Statements, Lux level calculations and other related work of Electrical Designing.

She has experience in C++, Auto-CAD, MS-Office, Computer Architecture, Lighting level calculation software like Calculux and other windows-based packages and actively taking part in our various projects.

#### **List of Projects**

1. Habib Oil Mills
2. S.B. Textile
3. Platinum Pharmaceutical
4. Rajwani Denim Mills Pvt Ltd.
5. Artistic Milliner-Garment Unit Karachi.
6. YTM-2 Building B
7. Artistic Denim Mills
8. Habib Bank Plaza-Dynamic LED Fascade Lighting
9. Sidiqsons Denim City, Hub.
10. Indus Motors-Canteen Area
11. A.D.M. – Office Building
12. Majid-E-Haq, PAF Malir Cantt.

\*\*\*\*\*



# A.E.A INTERNATIONAL (PVT.) LIMITED

## PLANNERS & CONSULTING ENGINEERS

### **ENGR. FATIMA AIJAZ**

B.E. (Electrical)

Engr. Fatima Aijaz is a highly skilled and dedicated Electrical Engineer, passed **Bachelor of Engineering in Electrical** from **NED University of Engineering and Technology, Karachi**, in February, 2021. With an outstanding academic track record and a passion for innovative electrical designs, she quickly made her mark in the industry.

Currently serving as a **Design Engineer** at **A.E.A. International (Pvt.) Ltd.**, Engr. Fatima plays a pivotal role in the design and execution of complex **LV/HV power distribution systems** and **electrical infrastructure** for high-profile projects.

#### **Key Skills:**

- Electrical Distribution System Design (LV/HV)
- Switchgear & Breaker Sizing
- Lighting Design & Scheme Development
- Fire Alarm, CCTV & Access Control Systems
- Bill of Quantities (BoQs) & Tender Documentation
- Cost Estimation & Project Budgeting
- Preparing Loadsheets
- Energy Modelling
- Technical & Commercial Proposals
- Presentations

#### **Technical Expertise & Tools Proficiency:**

- **AutoCAD** – Advanced proficiency in creating detailed electrical layouts and designs.
- **PVsyst**– Expertise in solar energy design and simulation.
- **DiaLux** – Competence in lighting design and energy-efficient solutions.
- **MS Office** – Excellent command over Excel, Word, and PowerPoint for project documentation and reporting.

\*\*\*\*\*



# A.E.A INTERNATIONAL (PVT.) LIMITED

## PLANNERS & CONSULTING ENGINEERS

### ENGR. NABEEL AHMED BAIG

B.E Electrical (Power)

Mr. Nabeel Ahmed Baig graduated from DHA Suffa University in 2018 and has done many courses in the field of Electrical, Electronics, Automation, Advertisement and Computer softwares.

Mr. Nabeel holds a technical background from his early age and has been involved in many industrial projects from their planning to their respective execution.

From designing a SCADA system for his final year project in university, he has clear concepts of control systems and power distribution.

In Advance Engineering he has been working on preventive maintenance of many factories and has performed Thermographic test of switchgear equipment for more the 30 Factories. He has also been involved in other electrical equipment test like Magger test (Insulation Resistance Test), Earthing test etc.

He has also been involved in electrical rectification of factories with new electrical distribution systems replacing existing DBs & Panels and designing of new switchgear and its respective architecture this also includes preparing complete BOQ and necessary documents to justify the rectification process.

Designing of New Power houses and amendments in existing Powerhouse to enhance their capacity, new connection from grids and their related designing of switchgear, busways, HT AVR's, Transformers (Oil & Dry Type) including designing the system in a manner so that it sync properly.

Re-energizing of departments via Electrical busway system, good experience in formation of electrical documentation required for all international audit firms.

\*\*\*\*\*



# A.E.A INTERNATIONAL (PVT.) LIMITED

## PLANNERS & CONSULTING ENGINEERS

### SAQIB AHMED KHAN

Site Engineers

B-Tech (Electrical)

He has been working on preventive maintenance of many factories and has performed Thermographic test of switchgear equipment for more the multiple Factories. He has also been performed electrical test like (Cable Insulation Resistance Test), Earthing test etc.

He has also been involved in electrical rectification of factories with new electrical distribution systems replacing existing DBs & Panels and designing of new switchgear and its respective architecture this also includes preparing complete BOQ and necessary documents to justify the rectification process.

Site Survey to collect data and develop design. He has also prepared Survey Reports (Safety Survey, Site Conditioning Report, power Analysis Report, etc.) and electrical Bills verification work for client.

\*\*\*\*\*



# A.E.A INTERNATIONAL (PVT.) LIMITED

## PLANNERS & CONSULTING ENGINEERS

### **ENGR. HUMERA EJAZ**

B.E. (Electrical)

Engr. Humera Ejaz has passed her B.E-Electrical with 1st Division (2.8 CGPA) in Dec-2020 from NED University of Engineering and Technology, Karachi. She has good Academic Record and is excelling at our firm overlooking and has completed many projects on her own.

She joined Advance Engineering Associates as a “Design Engineer” in July-2022. She is responsible for designing LV/HV Electric Power Distribution system which includes Switchgear Equipment, Lighting Scheme, Breaker sizing, Cable sizing, Fire Alarm, CCTV & Access Control Systems, to prepare Tender Documents i.e. Bill of Quantities / Technical specifications, to compute budgetary cost based packages.

She also conducts energy audits and safety surveys of various sites.

She has Experience in Auto-Cad, MS-Office, MATLAB, DiaLux and other windows-based packages.

### **COMPLETED & ON-GOING PROJECTS:**

#### **Design Projects:**

- DL Nash (Pvt) Limited
- H.E. SULTAN KHALIFA AL Habtoor (Sharjah)
- IFFCO Pakistan Pvt. Ltd

\*\*\*\*\*



# A.E.A INTERNATIONAL (PVT.) LIMITED

## PLANNERS & CONSULTING ENGINEERS

### **ENGR. FATIMA HASSAN**

B.E. (Electrical)

Engr. Fatima Hassan has passed her B.E-Electrical with 1st Division (3.0 CGPA) in Dec-2020 from NED University of Engineering and Technology, Karachi. She has an excellent Academic Record and is excelling at our firm overlooking and has completed many projects on her own.

She joined Advance Engineering Associates as a "Design Engineer" in Aug-2022. She is responsible for designing LV/HV Electric Power Distribution system which includes Switchgear Equipment, Lighting Scheme, Breaker sizing, Cable sizing, Fire Alarm, CCTV & Access Control Systems, to prepare Tender Documents i.e. Bill of Quantities / Technical specifications, to compute budgetary cost based packages.

She also conducts energy audits and safety surveys of various sites.

She has Experience in Auto-Cad, MS-Office, MATLAB, DiaLux and other windows-based packages.

### **COMPLETED & ON-GOING PROJECTS:**

#### **Design Projects:**

- DL Nash (Pvt) Limited
- H.E. SULTAN KHALIFA AL Habtoor (Sharjah)
- IFFCO Pakistan Pvt. Ltd

\*\*\*\*\*



# A.E.A INTERNATIONAL (PVT.) LIMITED

## PLANNERS & CONSULTING ENGINEERS

### **FOUZIA**

#### **Accountant & Admin Officer**

#### **Advance Engineering Associates | A.E.A International (Pvt). 2007 – Present**

Since joining the company in 2007, Ms. Fouzia has been responsible for overseeing essential administrative and financial tasks that support the smooth functioning of the office and contribute to the company's overall efficiency. Her dual role in both accounting and administration has been integral to maintaining an organized, efficient, and financially transparent work environment.

#### **Key Responsibilities & Achievements:**

- **Financial Management:**
  - Manage **daily, monthly, and yearly account balances** and maintain meticulous **financial records**.
  - Oversee **petty cash management, billing, and salaries processing**, ensuring timely and accurate payments.
  - Ensure the proper handling and recording of **banking transactions** and reconciliation of accounts.
- **Administration & Office Coordination:**
  - Supervise a range of **administrative functions**, including managing office supplies, scheduling meetings, and coordinating logistics.
  - Maintain and organize key **company documents**, including **tenders, proposals, quotations**, and other critical correspondence.
  - Act as a key point of contact for clients, addressing inquiries, managing communications, and ensuring smooth administrative processes.
- **Document Management & Compliance:**
  - Ensure all financial and administrative documents are accurately filed and stored in compliance with company policies and regulatory requirements.
  - Manage and update **internal reports**, ensuring accuracy and timeliness in all financial and administrative submissions.

\*\*\*\*\*



**A.E.A INTERNATIONAL (PVT.) LIMITED**  
**PLANNERS & CONSULTING ENGINEERS**

**MARYAM REHMAN**

Assistant Admin/Accounts Officer

Ms. Maryam Rehman has done Bachelor in 2020 from University of Karachi.

She has joined Advance Engineering in 2023. She has excellent administration skills, maintaining Petty Accounts, Billing, Daily Banking, Salaries, comparatives, attendance statement & supervise various administration matters, maintain various documents of office like Tender etc.,

She has command in MS Office and excellent expertise in MS Excel. She is responsible to maintain daily, monthly and yearly account balance and all financial documents.

\*\*\*\*\*



**A.E.A INTERNATIONAL (PVT.) LIMITED**  
**PLANNERS & CONSULTING ENGINEERS**

**SYED MUHAMMAD ZEESHAN BUKHARI**

**Sr. Draftsman**

Mr. Zeeshan Bukhari joined the organization in June 2005, he is working as Auto-CAD designer.

He has completed Intermediate in 1998.

Mr. Zeeshan Bukhari has in depth experience of Auto-CAD Designing.

He also has a very good command on other packages like, M.S. Office & M.S. Dos.

\*\*\*\*\*



**A.E.A INTERNATIONAL (PVT.) LIMITED**  
**PLANNERS & CONSULTING ENGINEERS**

**MUHAMMAD WASEEM**

**Sr. Draftsman**

Mr. Muhammad Waseem joined the organization in April 2007; He is working as Auto CAD Designer.

He has completed Graduation (B.Com) from Karachi University and DAE Electrical Engineering. He has also done various Computer Certifications Courses.

He is also working in 2D & 3D designing, planning and visualization.

He is also a very good AutoCAD Draftsman & very much involved in electrical designing of at various projects.

\*\*\*\*\*



**A.E.A INTERNATIONAL (PVT.) LIMITED**  
**PLANNERS & CONSULTING ENGINEERS**

**MOHAMMAD WAJID**  
**Sr. Draftsman**

Diploma of Associate Engineers.

From 1996 to 1998 he worked with W. J. Associates as an Electrical Draftsman.

He joined as a Senior Electrical Draftsman and till the date he is in this organization.

He has complete command over Computer packages like DOS, WINDOWS.95, MS.WORD, MS-EXCEL. WORD STAR, LOTUS 123(R-5), POWER POINT, AUTO-CAD.

\*\*\*\*\*



**A.E.A INTERNATIONAL (PVT.) LIMITED**  
**PLANNERS & CONSULTING ENGINEERS**

**BILAWAL AHMED**

**I.T. Support Engineer**

He joined AEA as an "I.T. Support Engineer Since 01-December-2020

He has complete command over computer packages like DOS, WINDOWS-95-98, MS-WORD, MS-EXCEL, WORD STAR, LOTUS 123 (R-5), POWER POINT, AutoCad-13-14, Internet, Email and has some Knowledge of FOX-PRO.

He resolves all the issues of IT and other related works very quickly and securely.

\*\*\*\*\*



**A.E.A INTERNATIONAL (PVT.) LIMITED**  
**PLANNERS & CONSULTING ENGINEERS**

**ALTAMASH HUSSAIN**

**OFFICE ASSISTANT**

Mr. Altamash completed his Matriculation in 2002 from Karachi Board. He assists other staff in all kind of Office activities & outdoor works.

\*\*\*\*\*



**A.E.A INTERNATIONAL (PVT.) LIMITED**  
**PLANNERS & CONSULTING ENGINEERS**

**LIST OF TECHNICAL STAFF FOR PLUMBING WORKS**

- Executive : Engr. Wahid Rizvi  
& Engr. Muhammad Tanveer,  
Engr. Nadeem Ahmed & Engr. Zubair
- Engineers : Engr. Zahid Abbasi & Engr. Azhar Hussain
- Design & drafting team : Ms. Shazia Zahid, Ms. Saima Begum,  
Ms. Zubia Arif & Mr. Abdul Karim
- Supervision team : Engr. Intekhab, Engr. Shafiullah  
& Engr. Anwar
- Computer operator : Mr. Owais Khan



# CERTIFICATE / PURCHASE ORDERS



# Hamdard Laboratories (WAQF) Pakistan

## Service Order

Sales Tax Registration No. 02-02-21-06-001-37  
National Tax No. 0700900-3

Status : Approved

Date : 12-12-2024

SO No. : 4700005761

### Vendor Name & Address

2600937 REG # : 5412786

A.E.A International Pvt Ltd

313, Anum Estate, Shahrae Faisal, , Karachi

Ph # : +92 335 3275258 , 021-34311985

Email :

Plant : H002

HIC - MED

(For Internal Reference Only)

SR No. : 3800001973 / Engineering Store

Collective No. :

S.No.	Service Code	Service Description	Quantity/Req No. of jobs	UOM	Curr	Unit Price	Value	Services Tax %	Tax Amount	Freight Charges	Total Amount	Delivery Date	Tax Code
1	2100543	Electrical Consultancy service for OSD	1	AU	PKR			15.00		0.00		09-12-2024	IS
												Grand Total:	
												0.00	

Amount in Words :

### Special Instruction

#### Services Location / Address

**HAMDARD INDUSTRIAL COMPLEX, DEH HALKANI, SHAHEED HAKIM  
MUHAMMAD SAEED ROAD, OPPOSITE HUB PUMPING STATION.  
Karachi  
92-300-8294580**

#### Terms of Payment

**Advance Payment**

#### Standard Terms and Conditions

- The Supplier is obliged to deliver the agreed quantity on the specified delivery date as per the terms of the Purchase Order (PO).
- Acknowledgment of PO receipt must be confirmed via email.
- All shipments are to be made at the Supplier's transporter risk, and the Supplier shall bear any facilities arising from transit issues.
- All deliveries are subject to quality and quantity approval.
- Each delivery must be accompanied by:
  - The relevant PO number, (B) The Original Delivery Challan (DC), (C) A Certificate of Analysis (COA)
- Invoices will not be processed if the PO number is not clearly mentioned on the Delivery Challan and Invoice
- Credit terms will commence from the submission date of original invoices, duly meeting all pre-shipment conditions.
- If the Supplier fails to deliver the material within the agreed time frame or the material is rejected (due to non-compliance with quality control parameters, resulting in production disruption, the Purchaser reserves the right to procure the required material from the open market. Any price difference incurred will be recovered from the Supplier via a Debit Note
- Hamdard reserves the absolute right to cancel any order at its discretion without providing any reason.
- These terms are binding and enforceable as part of the supply agreement. Non-compliance may result in penalties or legal action as deemed appropriate by the Purchaser.
- The supplier is responsible to comply all the ethical, legal, environmental, regulatory, health, safety requirements. In case of any non-compliance/ violation we will not be responsible for any liability/damage.

**This is a computer-generated document and does not require signatures.**

# Purchase Order

**PO No.** PO-000115657  
**PO Date** 26/12/2024

<b>Vendor Name</b>	A.F.A. INTERNATIONAL (PRIVATE) LIMITED	<b>Bill To</b>	Ideas (Pvt) Limited
<b>Contact Person</b>		<b>Contact Person</b>	
<b>Address</b>	313, ANJUM ESTATE, SHAHRAH-E- FAISAL,KARACHI, Sindh, Karachi, PAK	<b>Address</b>	Plot 65/1, Sector 30 Korangi Industrial Area, Karachi , Sindh PAK
<b>Phone</b>		<b>Phone</b>	(92-21) 111486486
<b>Fax</b>		<b>Fax</b>	
<b>Sales Tax Reg. #</b>		<b>Sales Tax Reg. #</b>	32-77-8762-501-11 <b>NTN #</b> 2276732-7
<b>Buyer Name</b>	shaikh.moiz	<b>Shipping Method</b>	
<b>Phone</b>		<b>Shipping Terms</b>	
<b>Payment Terms</b>	50% Advance & 50 % After Delivery	<b>Freight Carrier</b>	
<b>Req #</b>		<b>Agency Reference</b>	

**Deliver To:** FS Burewala

**Address:** Punjab,  
Burewala,  
Central 1B,

Item Id	Item Description	UOM	Delivery Date	Qty. / No. Of Elements	Rate	Amount	Tax Rate	Tax Amount	Total Amount
CONSULTANCY CHARGES	CONSULTANCY CHARGES	EA	26/Dec./2024	1					
<b>Cost Center</b>		Fabric Outlet		<b>Color:</b>	<b>Size:</b>	<b>Config:</b>			
<b>Remarks:</b>		CONSULTANCY PROPOSAL FOR ELECTRICAL AUDIT & SAFTEY SURVEY AT IDEAS BUREWALA							

**Sub Total:**

**Freight & Other Charges:**  0.00

**Advance Tax:**  0.00

**Grand Total:**

**Terms & Conditions**

1. Delivery time is from 9:00 AM to 5:30 PM after or before this timeframe delivery will not be entertained and material must be re-supplied.
2. In case of Any Tax exemption documents needs to be provided for non-deduction with Invoice.
3. Reference of P/O number should be mentioned on Delivery Challan.
4. Invoices shall be entertained as per payment terms agreed and after satisfactory completion of services & supplies.
5. Delivery Challan with location receiving should be attached with Invoice.
6. Vendee reserves the right to cancel the order, if not delivered on the given/agreed deadline.
7. Vendee reserves the right to reject/return the consignment if it deviates from the material quality ordered for.
8. Vendee reserves the right to file a sue in case of any claim on the Vendor.
9. Any tax implication levied by Government of Pakistan will be applied.
10. If you find any instances of malpractice at IDEAS, Please raise your concerns as early as possible at IDC@ideas.com.pk
11. IDEAS Employee do not accept any kind of gifts commissions or gratitude in form of cash from any of its vendor. Incase of any such incident reported the Company reserves the right to take strict action against them as per policy.

<b>Approval</b>	<b>Approval</b>

<b>Vendor Name</b>	A.E.A. INTERNATIONAL (PRIVATE) LIMITED	<b>Bill To</b>	Ideas (Pvt) Limited
<b>Contact Person</b>		<b>Contact Person</b>	
<b>Address</b>	313, ANJUM ESTATE, SHAHRAH-E- FAISAL,KARACHI, Sindh, Karachi, PAK	<b>Address</b>	Plot 65/1, Sector 30 Korangi Industrial Area, Karachi, Sindh PAK
<b>Phone</b>		<b>Phone</b>	(92-21) 111486486
<b>Fax</b>		<b>Fax</b>	
<b>Sales Tax Reg. #</b>		<b>Sales Tax Reg. #</b>	32-77-8762-501-11
		<b>NTN #</b>	2275732-7
<b>Buyer Name</b>	shaikh.moiz	<b>Shipping Method</b>	
<b>Phone</b>		<b>Shipping Terms</b>	
<b>Payment Terms</b>	30 Days	<b>Freight Carrier</b>	
<b>Req #</b>		<b>Agency Reference</b>	

**Deliver To:** Clifton

**Address:** Sindh,  
Karachi,  
South 1A,  
PAK

Item Id	Item Description	UOM	Delivery Date	Qty. / No. Of Elements	Rate	Amount	Tax Rate	Tax Amount	Total Amount
CONSULTANCY CHARGES	CONSULTANCY CHARGES	EA	28/Nov/2024	1	150,000.00	150,000.00	15.00	22,500.00	172,500.00
<b>Cost Center</b>	Ideas Outlet	<b>Color:</b>		<b>Size:</b>		<b>Config:</b>			
<b>Remarks:</b>	CONSULTANCY CHARGES FOR ELECTRICAL AUDIT & SAFETY SURVEY AT IDEAS OUTLET CLIFTON								

**Sub Total:** 150,000.00      22,500.00      172,500.00

**Freight & Other Charges:** 0.00

**Advance Tax:** 0.00

**Grand Total:** 150,000.00      22,500.00      172,500.00

**Terms & Conditions**

1. Delivery time is from 9:00 AM to 5:30 PM after or before this timeframe delivery will not be entertained and material must be re-supplied.
2. In case of Any Tax exemption documents needs to be provided for non-deduction with Invoice.
3. Reference of P.O number should be mentioned on Delivery Challan.
4. Invoices shall be entertained as per payment terms agreed and after satisfactory completion of services & supplies.
5. Delivery Challan with location receiving should be attached with Invoice.
6. Vendee reserves the right to cancel the order, if not delivered on the given/agreed deadline.
7. Vendee reserves the right to reject/return the consignment if it deviates from the material quality ordered for.
8. Vendee reserves the right to file a sue in case of any claim on the Vendor.
9. Any tax implication levied by Government of Pakistan will be applied.
10. If you find any instances of malpractice at IDEAS, Please raise your concerns as early as possible at IDC@ideas.com.pk
11. IDEAS Employee do not accept any kind of gifts commissions or gratitude in form of cash from any of its vendor. In case of any such incident reported the Company reserves the right to take strict action against them as per policy.

<b>Approval</b>	<b>Approval</b>



# GHANDHARA INDUSTRIES LTD.

## Purchase Order - Contract / Civil

P.O Service

F-3, HUB CHUAKI ROAD, S.I.T.E. P.O. BOX NO. 75730

Phone: 021-111-445-111, 021-38709000, 021-32560083-86, 0800-11190, -1 Fax : 021-32564458, 021-32560090

GST No. 02-03-8702-001-73

Our N. Tax No. 0816963-2

<b>SUPPLIER CODE</b> 901903	<b>SUPPLIER :</b> A.E.A. INTERNATIONAL (PRIVATE)	<b>PO # :</b> 0000001188	<b>DATE :</b> 21/10/2024
<b>ADDRESS :</b>		<b>PR # :</b> 0000000646	<b>DATE :</b> 14/10/2024
<b>PHONE :</b>	<b>MOBILE NO :</b>	<b>JOB ORDER :</b>	
<b>NTN/STN:</b> 5412786-6	<b>STRN:</b> SRB REGISTERED	<b>DEPARTMENT :</b> Production	

**DELIVERY AT** : Warehouse - GIL Plant

**PAYMENT TERMS** : 25%ADV 25%INT SH & 50% AGT DEL

S.No	Item Description	Packs	Unit	Rate	Narration	Amount
1	( 5010070001 ) NEW BUS LINE PROJECT Narration : MEP Consultancy Requirement for new Bus Body line	1.00	JOB		MEP Consultancy Requirement for new Bus Body line	

<b>REMARKS</b> Service Required for the MEP Consultancy for the project new Bus Body Line (Payment term as per decided)
--

<b>TOTAL</b>	:	
<b>ADD TOTAL G.S.T</b>	:	
<b>ADD FURTHER TAX</b>	:	
<b>LESS DISCOUNT</b>	:	
<b>CARTAGE / OTHERS</b>	:	
<b>NET PAYABLE</b>	:	_____

Amount in words :

### TERMS & CONDITIONS

- 1 Delivery shall get accept on following documents:
- 2 -Original Delivery Challan having reference of attached PO
- 3 Prices quoted are final for the total quantity and during the entire delivery schedule
- 4 Unless otherwise stated, the prices mentioned cover all expenses up to Gandhara Industries Limited premises
- 5 The Buyers assume no obligation in relation to any goods delivered in excess of those specifically ordered
- 6 Items delivered after the lapse of required date mentioned on PO or 3-6 months from PO date (whichever is earlier) may fully or partially be rejected
- 7 Store receiving timings should strictly be followed which are till 4:00 PM on working day
- 8 Items to be delivered in a package / packing (which should specifically be mentioned on PO) as agreed at the time of negotiation
- 9 All goods delivered are subject to approval by GIL quality department and if found unsatisfactory, GIL reserve the right to reject the same.
- 10 All invoices should be submitted immediately after delivery, failing which payment may get delayed
- 11 The buyer reserves the rights to cancel or amend the order in full / part thereof without assigning any reasons.

**This is a system generated document and does not require signatures. Any manual alteration or changes will make the document null and void.**

TAYYAB

UZAIR

AUDIT

PREPARED BY

VERIFIED BY

CHECKED BY

APPROVED BY



**Artistic Garment Industries (AGI Denim) (Pvt.) Ltd.**  
MANUFACTURER & EXPORTER OF YARN, DENIM FABRICS & FASHION  
GARMENTS

Plot #53,54,71,72 Sector 28, Korangi Industrial Area, Karachi  
Phone: 92-2137132233/92-2135035501  
GST: 12-02-6200-003-82, NTN: 0709709-3

Pcm/pur/4/009  
Issue#01  
Date:08-07-2008

**Standard Purchase Order**

Supplier: A.E.A INTERNATIONAL (PVT.) LIMITED PO Number(0): 273242  
Address: Suite 313, 3rd Floor, Anum Estate, Shahrah e Faisal, Karachi Karachi PK Purchase Order Date: 02-SEP-24  
Phone: Department: WASHING  
Mobile: Project:  
Email: Unit: (K2) AGI-2, Plot#71,72, Sector 28, KIA, Karachi.Karachi  
N.T.N: 5412786 Bill To: Plot #53,54,71,72 Sector 28, Korangi Industrial AreaKarachi  
S.T.R.N :  
Location: Department(Buyer):  
Status: **APPROVED** Creation Type : Auto Create

S.NO	Item Description	UOM	Qty	Rate (PKR)	Discount	Tax Code	Net Rate(PKR)	Last Supplier	Stock in hand	Last Purchase Price	Value (PKR)
1	Consultancy Fee of M.E.P Works of New Washing	JOB	1.00		0.0000			A.E.A INTERNATIONAL (PVT.) LIMITED	0		

**Total:** 0.00 PKR

**TERMS & CONDITIONS:**

If GST/Bill /Commercial Invoice will be sent after 5<sup>th</sup> of the following month, payment will be delayed  
Delivery Required Immediately  
\*Your product should comply with Inditex Clear to Wear (CTW) Requirements 2010.  
PAYMENT: 50%adv,remain pay as per quotation pay schedule.

**REMARKS:**

\_\_\_\_\_  
NAVEED.MALIK  
Prepared by  
Incharge

\_\_\_\_\_  
Checked By  
Audit/Accounts

\_\_\_\_\_  
WAQAR AHMED  
Authorized By  
HO/TD/GM

\_\_\_\_\_  
Approved By  
Director

Print By: WASEEM.SALEEM  
Print Date:9/6/2024 16:13 PM

Garment Division - K2/ AGI-2, Plot#71.72, Sector 28, KIA, Karachi.Karachi  
This is a System Generated Report & may not require Signatures

PO NUMBER: 273242  
RDF Name:PO\_PURCHASE\_ORDER  
Page 1 of 1



**Artistic Garment Industries (AGI Denim) (Pvt.) Ltd.**  
MANUFACTURER & EXPORTER OF YARN, DENIM FABRICS & FASHION GARMENTS  
Plot #53,54,71,72 Sector 28, Korangi Industrial Area, Karachi

Phone: 92-2137132233/92-2135035501  
GST: 12-02-6200-003-82, NTN: 0709709-3  
EFS-KPQE-0709709-164-18-07-2023  
Validity: 19-07-2023 to 19-07-2026  
License Certificate: EFS-KPQE-0709709-164-18-07-2023

PCM/PUR/4/009

Issue#02

Date: 11-06-2019

**Standard Purchase Order**

Supplier Code: 9068 PO Number(0): 555  
Supplier: A.E.A INTERNATIONAL (PVT.) LIMITED Purchase Order Date: 27-SEP-24  
Address: Suite 313, 3rd Floor, Anum Estate, Department: Fiber Dyeing  
Shahrah e Faisal, Karachi Karachi PK  
Phone: PR No: 602  
PR Date: 20-SEP-24 PR Approval Date: 20-SEP-24  
Mobile: Project: -  
Email: Unit: (AFD) Plot No. 14, Survey No. 16, 17, Deh Khando, Bin Qasim  
Town, Main National Highway Karachi  
N.T.N: 5412786 Bill To: Plot #53,54,71,72 Sector 28, Korangi Industrial  
Area Karachi  
S.T.R.N: PI Number:  
Location: Department (Buyer):  
Unit Name: AGI Fiber Dyeing Job #  
Status: APPROVED 01-OCT-24 Creation Type: Auto Create

S.#	Prefix	Item Description	Detail /	Need by Date	UOM	Qty	Rate (PKR)	DISC	Tax Code	Net Rate (PKR)	Value (PKR)
1	80000	Service and Labour charges	AGI Fiber Dyeing Consultation of New Building Expansion		JOB	1.00					

Total: PKR

**Invoice must be submitted to accounts department within seven days after delivery completion.**

**TERMS & CONDITIONS:**

If GST/Bill /Commercial Invoice will be sent after 5<sup>th</sup> of the following month, payment will be delayed

Delivery Required Immediately

All goods must be comply with latest version of inditex CTW & MRSL.

All goods delivery must be in original container & original labels include with product name, manufacturing name and Lot # on it.

PAYMENT: 50% Advance 25% At Time Of Delivery 25% Final Del

**REMARKS:**

LC/TT//FDBC/FOC #: 124100,124100,124100,124100

RIZWAN.PRC

Prepared by  
In charge

Checked By  
Audit/Accounts

Authorized By  
HO/TD/GM

Approved By  
Director

Print By: RIZWAN.PRC  
Print Date: 10/1/2024 13:02 PM

Head Office/ Plot No. 14, Survey No. 16, 17, Deh Khando, Bin Qasim Town, Main National Highway Karachi

This is a System Generated Report & may not require Signatures



# TAJ GASOLINE PVT. LTD

Head Office: Office No. 01, First Floor, Bahria Complex IV, Left Wing,  
Chaudry Khaliq uz Zaman Road, Clifton, Karachi, Pakistan  
Phone: 021-35155027-8 | Email: info@tajgasoline.com | Website: www.tajgasoline.com  
NTN # 7214049-0 | STRN # 3277876148063

## PURCHASE ORDER

### Vendor Information

Vendor : V-001109 | A.E.A. International (Private) Limited  
Address : PAK  
Phon :  
NTN # 5412786  
STR #  
Project Site : Karachi

### PURCHASE ORDER INFORMATION

Purchase Order No : TGPL-PO-002743  
Purchase Order Date : 13-Jul-24  
Vendor Currency: PKR  
Inc. tax borne by TGPL : NO  
Sales tax borne by TGPL: NO

No.	Item code	Item description	UOM	Qty	Unit Price	Amount Exclusive Sales Tax	ST Rate	ST Amount	Amount Inclusive Sales Tax
1	RM00003299	Consultancy Proposal For Electrical Work	EA	1.00		-		-	
Total Amount - Excl Tax :									
General Sales Tax :									-
Total Amount - Incl Tax :									
Other Charges :									
Total Gross :									

### PURCHASE ORDER TERMS :

- DELIVERY DATE : 8/25/2023
- DELIVERY ADDRESS : Head Office
- PAYMENT TERM: Advance | 1. 25% Advance along with work order.  
2. 25% on submission of Conceptual Design Drawing.  
3. 25% On submission detail design & BOQ.  
4. 25% During the execution of work.

### GENERAL TERMS :

- PRICE AGREED SHALL BE FINAL, NO UPWARD VARIATION / CHANGES ARE ALLOWED.
- NO DEVIATION IS ACCEPTABLE IN SUPPLIED MATERIAL WITHOUT WRITTEN APPROVAL FROM PURCHASING AUTHORITY.
- COUNTRY OF ORIGIN/ MAKE/MODEL NO./PART NO. MUST BE MENTIONED ON INVOICE & DELIVERY CHALLAN.
- HARDCOPY OF INVOICES & DELIVERY CHALLAN MUST BE SUBMITTED TO HEAD OFFICE.
- PURCHASE ORDER NUMBER MUST APPEAR ON ALL THE INVOICES/ DELIVERY CHALLANS AND CORRESPONDANCE ETC.
- IN CASE OF LATE DELIVERY , DEDUCTION FROM TOTAL AMOUNT WILL COME IN EFFECT.
- IN CASE OF FORGED / REFURBISH / POOR QUALITY MATERIAL, TGPL RESERVE THE RIGHT TO REJECT / REPLACE MATERIAL AT VENDOR'S COST IN CASE OF NON-COMPLIANCE , VENDOR WILL BE BLACKLISTED AND FURTHER LEGAL ACTION WILL BE TAKEN.
- ALL THE PAYMENTS WILL BE SUBJECTED TO DEDUCTION OF WITHOLDING TAX UNDER INCOME TAX ORDINANCE PREVAILING AT THE TIME OF PAYMENT . PLEASE PROVIDE CERTIFICATE / UNDERTAKING IN CASE VENDOR IS TAX EXEMPTED.



VENDOR ACCEPTANCE  
(SIGN & SEAL)



**Artistic Garment Industries (AGI Denim) (Pvt.) Ltd.**  
MANUFACTURER & EXPORTER OF YARN, DENIM FABRICS & FASHION  
GARMENTS

Plot #53,54,71,72 Sector 28, Korangi Industrial Area, Karachi  
Phone: 92-2137132233/92-2135035501  
GST: 12-02-6200-003-82, NTN: 0709709-3  
EFS-KPQE-0709709-164-18-07-2023  
Validity: 19-07-2023 to 19-07-2028

Pcm/pur/4/009  
Issue#01  
Date:08-07-2008

**Standard Purchase Order**

Supplier: A.E.A INTERNATIONAL (PVT.) LIMITED  
Address: Suite 313, 3rd Floor, Anum Estate, Shahrah e Faisal, Karachi Karachi PK  
Phone: Department: ELECTRICAL  
Mobile: Project:  
Email: Unit: (K5) AGI-2, Plot#71.72, Sector 28, KIA, Karachi.Karachi  
N.T.N: 5412786 Bill To: Plot #53,54,71,72 Sector 28, Korangi Industrial AreaKarachi  
S.T.R.N :  
Location: Department(Buyer):  
Remarks: Req from Electrical Dep., PR# 125035 Creation Type : Auto Create  
Status: **APPROVED**

S.N O	Prefix	Item Description	Remarks	UOM	Quantity	Rate	DISCOUNT	Tax Code	Net Rate	Value
1	80000	Consultancy of Electrical Work Office Electrification Work. HVAC System. Final Design		JOB	1.00		0.0000	INPUT ST @ 13%		
<b>Total :</b>										
1.00 PKR										

**TERMS & CONDITIONS:**

If GST/Bill /Commercial Invoice will be sent after 5<sup>th</sup> of the following month, payment will be delayed  
Delivery Required Immediately  
PAYMENT: 50%adv,remain pay as per quotation pay schedule.

**REMARKS:**

Req from Electrical Dep.  
, PR# 125035

FAHAD ALI  
Prepared by  
Incharge

Checked By  
Audit/Accounts

WAQAR AHMED  
Authorized By  
HO/TD/GM

Approved By  
Director

Print By: FAHAD ALI  
Print Date:12/20/2023 15:48 PM

PO NUMBER: 245584

PDF Name: PO\_PURCHASE\_REMARKS\_AFGI

Page 1 of 1

Garment Division - K5/ AGI-2, Plot#71.72, Sector 28, KIA, Karachi.Karachi  
This is a System Generated Report & may not require Signatures



**Artistic Garment Industries (AGI Denim) (Pvt.) Ltd.**  
MANUFACTURER & EXPORTER OF YARN, DENIM FABRICS & FASHION  
GARMENTS

Plot #53,54,71,72 Sector 28, Korangi Industrial Area, Karachi

Phone: 92-2137132233/92-2135035501

GST: 12-02-6200-003-82, NTN: 0709709-3

Pcm/pur/4/009

Issue#01

Date:08-07-2008

**Standard Purchase Order**

Supplier: A.E.A INTERNATIONAL (PVT.) LIMITED  
Address: Suite 313, 3rd Floor, Anum Estate, Shahrah e Faisal, Karachi Karachi PK  
Phone:  
Mobile:  
Email:  
N.T.N: 5412786  
S.T.R.N :  
Location:  
Status: **APPROVED**

PO Number(0): 245575  
Purchase Order Date: 14-DEC-23  
Department: ELECTRICAL  
Project:  
Unit: (K2)  
Bill To: AGI-2, Plot#71,72, Sector 28, KIA, Karachi.Karachi  
Plot #53,54,71,72 Sector 28, Korangi Industrial AreaKarachi  
Department(Buyer):  
Creation Type : Auto Create

S.NO	Item Description	UOM	Qty	Rate (PKR)	Discount	Tax Code	Net Rate(PKR)	Last Supplier	Stock in hand	Last Purchase Price	Value (PKR)
1	Consultancy of IT Department Wxamine the plan. Compute Total Electrical Load requirements. Concept Designs	JOB	1.00		0.0000			A.E.A INTERNATIONAL (PVT.) LIMITED	0		

**Total: PKR**

**TERMS & CONDITIONS:**

If GST/Bill /Commercial Invoice will be sent after 5<sup>th</sup> of the following month, payment will be delayed

Delivery Required Immediately

\*Your product should comply with Inditex Clear to Wear (CTW) Requirements 2010.

PAYMENT: 50%adv,remain pay as per quotation pay schedule.

**REMARKS:**

Req from Electrical Dep.

, PR# 125033

FAHAD ALI  
Prepared by  
Incharge

Checked By  
Audit/Accounts

WAQAR AHMED  
Authorized By  
HO/TD/GM

Approved By  
Director

Print By: JUNAID KHAN  
Print Date:12/18/2023 15:41 PM

Garment Division - K2/ AGI-2, Plot#71.72, Sector 28, KIA, Karachi.Karachi  
This is a System Generated Report & may not require Signatures

PO NUMBER: 245575  
RDF Name:PO\_PURCHASE\_ORDER  
Page 1 of 1



**Artistic Garment Industries (AGI Denim) (Pvt.) Ltd.**  
MANUFACTURER & EXPORTER OF YARN, DENIM FABRICS & FASHION  
GARMENTS

Plot #53,54,71,72 Sector 28, Korangi Industrial Area, Karachi  
Phone: 92-2137132233/92-2135035501  
GST: 12-02-6200-003-82, NTN: 0709709-3  
EFS-KPQE-0709709-164-18-07-2023  
Validity: 19-07-2023 to 19-07-2028

Pcm/pur/4/009  
Issue#01  
Date:08-07-2008

**Standard Purchase Order**

Supplier: A.E.A INTERNATIONAL (PVT.) LIMITED  
Address: Suite 313, 3rd Floor, Anum Estate, Shahrah e Faisal, Karachi Karachi PK  
Phone: Department: ELECTRICAL  
Mobile: Project:  
Email: Unit: (K2) AGI-2, Plot#71.72, Sector 28, KIA, Karachi.Karachi  
N.T.N: 5412786 Bill To: Plot #53,54,71,72 Sector 28, Korangi Industrial AreaKarachi  
S.T.R.N :  
Location: Department(Buyer):  
Remarks: Req from Electrical Dep., PR# 124411, For The Month Of December-2023 Creation Type : Auto Create  
Status: **APPROVED**

S.N O	Prefix	Item Description	Remarks	UOM	Quantity	Rate	DISCOUNT	Tax Code	Net Rate	Value
1	80000	Consultancy Contract for Safety Survey of Electrical Work.		JOB	1.00		0.0000			

Total : 1.00 PKR

**TERMS & CONDITIONS:**

If GST/Bill /Commercial Invoice will be sent after 5<sup>th</sup> of the following month, payment will be delayed  
Delivery Required Immediately  
PAYMENT: 100% Advance

**REMARKS:**

Req from Electrical Dep.  
, PR# 124411, For The Month Of December-2023

FAHAD ALI  
Prepared by  
Incharge

Checked By  
Audit/Accounts

WAQAR AHMED  
Authorized By  
HO/TD/GM

Approved By  
Director

Print By: FAHAD ALI  
Print Date:12/6/2023 16:47 PM

PO NUMBER: 244616

RDF Name: PO\_PURCHASE\_REMARKS\_AFGI

Page 1 of 1

Garment Division - K2/ AGI-2, Plot#71.72, Sector 28, KIA, Karachi.Karachi  
This is a System Generated Report & may not require Signatures



**Artistic Garment Industries (AGI Denim) (Pvt.) Ltd.**  
MANUFACTURER & EXPORTER OF YARN, DENIM FABRICS & FASHION GARMENTS  
Plot #53,54,71,72 Sector 28, Korangi Industrial Area, Karachi

Phone: 92-2137132233/92-2135035501  
GST: 12-02-6200-003-82, NTN: 0709709-3  
EFS-KPQE-0709709-164-18-07-2023  
Validity: 19-07-2023 to 19-07-2026  
License Certificate: EFS-KPQE-0709709-164-18-07-2023

PCM/PUR/4/009

Issue#02

Date: 11-06-2019

**Standard Purchase Order**

Supplier Code: 9066 PO Number(0): 47498  
Supplier: A.E.A INTERNATIONAL (PVT.) LIMITED Purchase Order Date: 14-DEC-23  
Address: Suite 313, 3rd Floor, Anum Estate, Department: POWER HOUSE  
Shahrah e Faisal, Karachi Karachi PK  
Phone: PR No: 232021  
PR Date: 13-DEC-23 PR Approval Date: 14-DEC-23  
Mobile: Project:  
Email: Unit: (DM1) Survey No. 16, 17, Deh Khando, Bin Qasim Town, Main  
National HighwayKarachi  
N.T.N: 5412786 Bill To: Survey No. 16, 17, Deh Khando, Bin Qasim Town, Main  
National HighwayKarachi  
S.T.R.N: PI Number:  
Location: Department (Buyer):  
Unit Name: AGI Denim Mill Job #  
Status: IN PROCESS Creation Type: Auto Create

S.#	Prefix	Item Description	Detail /	Need by Date	UOM	Qty	Rate (PKR)	DISC	Tax Code	Net Rate (PKR)	Value (PKR)
1	80000	Service Charges	Consultancy Charges for 02 Engine Installation+Critical Load Shifting+Solar System Installation	14-DEC-23	JOB	1.00		0.00	INPUT SRB @ 13%		

Total: PKR

**Invoice must be submitted to accounts department within seven days after delivery completion.**

**TERMS & CONDITIONS:**

If GST/Bill /Commercial Invoice will be sent after 5<sup>th</sup> of the following month, payment will be delayed

Delivery Required Immediately

All goods must be comply with latest version of inditex CTW & MRSL.

All goods delivery must be in original container & original labels include with product name, manufacturing name and Lot # on it.

PAYMENT: 50%adv,remain pay as per quotation pay schedule.

**REMARKS:**

-

LC/TT/IFDRC/FOC # :

RAMISH.KHAN

Prepared by  
In charge

Checked By  
Audit/Accounts

Authorized By  
HO/TD/GM

Approved By  
Director

Print By: RAMISH.KHAN  
Print Date: 12/14/2023 12:40 PM

AGI Denim Mill/ Survey No. 16, 17, Deh Khando, Bin Qasim Town, Main National HighwayKarachi

This is a System Generated Report & may not require Signatures



**Artistic Garment Industries (AGI Denim) (Pvt.) Ltd.**  
MANUFACTURER & EXPORTER OF YARN, DENIM FABRICS & FASHION  
GARMENTS

Plot #53,54,71,72 Sector 28, Korangi Industrial Area, Karachi  
Phone: 92-2137132233/92-2135035501  
GST: 12-02-6200-003-82, NTN: 0709709-3  
EFS-KPQE-0709709-164-18-07-2023  
Validity: 19-07-2023 to 19-07-2028

Pcm/pur/4/009  
Issue#01  
Date:08-07-2008

**Standard Purchase Order**

Supplier: A.E.A INTERNATIONAL (PVT.) LIMITED  
Address: Suite 313, 3rd Floor, Anum Estate, Shahrah e Faisal, Karachi Karachi PK  
Phone: Department: ELECTRICAL  
Mobile: Project:  
Email: Unit: (K2) AGI-2, Plot#71.72, Sector 28, KIA, Karachi.Karachi  
N.T.N: 5412786 Bill To: Plot #53,54,71,72 Sector 28, Korangi Industrial AreaKarachi  
S.T.R.N :  
Location: Department(Buyer):  
Remarks: Req from Electrical Dep., PR# 123529 12-month contract, every month payment in advance Creation Type : Auto Create  
Status: **APPROVED**

S.N O	Prefix	Item Description	Remarks	UOM	Quantity	Rate	DISCOUNT	Tax Code	Net Rate	Value
1	80000	Consultancy Contract for Safety Survey of Electrical Work.	This is Payment for the month of Nov-2023	JOB	1.00		0.0000			

Total :1.00 PKR

**TERMS & CONDITIONS:**

If GST/Bill /Commercial Invoice will be sent after 5<sup>th</sup> of the following month, payment will be delayed  
Delivery Required Immediately  
PAYMENT: 100% Advance

**REMARKS:**

Req from Electrical Dep.  
, PR# 123529

FAHAD ALI  
Prepared by  
Incharge

Checked By  
Audit/Accounts

WAQAR AHMED  
Authorized By  
HO/TD/GM

Approved By  
Director

Print By: FAHAD ALI  
Print Date:11/28/2023 12:08 PM

PO NUMBER: 243745

RDF Name: PO\_PURCHASE\_REMARKS\_AFGI

Page 1 of 1

Garment Division - K2/ AGI-2, Plot#71.72, Sector 28, KIA, Karachi.Karachi  
This is a System Generated Report & may not require Signatures



# TAJ GASOLINE PVT. LTD

Head Office: Office No. 01, First Floor, Bahria Complex IV, Left Wing,  
Chaudry Khaliq uz Zaman Road, Clifton, Karachi, Pakistan  
Phone: 021-35155027-8 | Email: ifo@tajgasoline.com | Website : www.tajgasoline.com  
NTN # 7214049-0 | STRN # 3277876148063

## PURCHASE ORDER

### Vendor Information

Vendor : V-001109 | a.e.a international (Pvt.) limited  
Address :  
Phon :  
NTN #  
STR #  
Project Site : Karachi

### PURCHASE ORDER INFORMATION

Purchase Order No : TGPL-PO-002743  
Purchase Order Date : 06-Sep-23  
Vendor Ref :  
Inc. tax borne by TGPL : NO  
Sales tax borne by TGPL: NO

No.	Item code	Item description	UOM	Qty	Unit Price	Amount Exclusive Sales Tax	ST Rate	ST Amount	Amount Inclusive Sales Tax
1	RM00003299	Consultancy Proposal For Electrical Work	EA	1.00	260,000.00	260,000.00	-	-	260,000.00
Total Amount - Excl Tax :									260,000.00
General Sales Tax :									-
Total Amount - Incl Tax :									260,000.00
Other Charges :									
Total Gross :									260,000.00

### PURCHASE ORDER TERMS :

- DELIVERY DATE : 8/25/2023
- DELIVERY ADDRESS : Head Office
- PAYMENT TERM: Advance | 1. 25% Advance along with work order.  
2. 25% on submission of Conceptual Design Drawing.  
3. 25% On submission detail design & BOQ.  
4. 25% During the execution of work.

### GENERAL TERMS :

- PRICE AGREED SHALL BE FINAL, NO UPWARD VARIATION / CHANGES ARE ALLOWED.
- NO DEVIATION IS ACCEPTABLE IN SUPPLIED MATERIAL WITHOUT WRITTEN APPROVAL FROM PURCHASING AUTHORITY.
- COUNTRY OF ORIGIN/ MAKE/MODEL NO./PART NO. MUST BE MENTIONED ON INVOICE & DELIVERY CHALLAN.
- HARDCOPY OF INVOICES & DELIVERY CHALLAN MUST BE SUBMITTED TO HEAD OFFICE.
- PURCHASE ORDER NUMBER MUST APPEAR ON ALL THE INVOICES/ DELIVERY CHALLANS AND CORRESPONDANCE ETC.
- IN CASE OF LATE DELIVERY , DEDUCTION FROM TOTAL AMOUNT WILL COME IN EFFECT.
- IN CASE OF FORGED / REFURBISH / POOR QUALITY MATERIAL, TGPL RESERVE THE RIGHT TO REJECT / REPLACE MATERIAL AT VENDOR'S COST IN CASE OF NON-COMPLIANCE , VENDOR WILL BE BLACKLISTED AND FURTHER LEGAL ACTION WILL BE TAKEN.
- ALL THE PAYMENTS WILL BE SUBJECTED TO DEDUCTION OF WITHOLDING TAX UNDER INCOME TAX ORDINANCE PREVAILING AT THE TIME OF PAYMENT . PLEASE PROVIDE CERTIFICATE / UNDERTAKING IN CASE VENDOR IS TAX EXEMPTED.

[Empty box for Vendor Acceptance]

VENDOR ACCEPTANCE  
(SIGN & SEAL)

**SOORTY ENTERPRISES (PRIVATE) LIMITED**  
**WORK ORDER**



Date : 17-Jun-2023

Order No SER2300661

Organization: 08

**Detail of Work to be Outsourced**

<b>Job Detail:</b> Electrical Work of 1No. 6.4MW Wartsila HFO Genset								
<b>Coordinating Person's:</b> Sheraz Ahmed								
<b>Designation:</b> Manager Electric and Electronics								
<b>Contractor Name:</b> A.E.A. INTERNATIONAL (PRIVATE) LIMITED (5412786-6)								
<b>Status :</b> N/A								
<b>Expected Start Date</b>	<b>Expected date of completion</b>	<b>Actual date of Completion</b>	<b>Material Provided by</b>					
<b>Mode of Payment:</b> Cheque	<b>Withholding Tax:</b> No	<b>Payment Terms:</b> 50% ADVANCE AGAINST PO & 50% AS PER RUNNING BILLS						
<b>SERVICE / LABOUR</b>								
<b>Description</b>	<b>DEPARTMENT</b>	<b>UOM</b>	<b>Quantity</b>	<b>Curr.</b>	<b>Price</b>	<b>S.Tax</b>	<b>S.T Amt</b>	<b>Amount</b>
CIP - CAPITAL WORK IN PROCESS - ELECTRICAL WORK CONSULTANCY	POWER HOUSE HFO - Denim Unit	num	1.00	PKR		13.00		
<b>Total Amount</b>								
<b>MATERIAL</b>								
<b>Description</b>	<b>UOM</b>	<b>Quantity</b>	<b>Curr.</b>	<b>Price</b>	<b>S.Tax %</b>	<b>S.T Amount</b>	<b>Amount</b>	
<b>Total Amount</b>								
<b>Estimated Cost of the Job</b>	<b>Material</b>	<b>Labour</b>	<b>Discount</b>	<b>Total</b>				

**Remarks** A.E.A INTERNATIONAL  
 DESCRIPTION:CONSULTANCY PROPOSAL OF OUR HFO PLANT (INCLUDING ELECTRICAL WORK)  
 TOTAL AMOUNT=  
 withholding tax:  
 DATE:19-MAY-2023

pur04-u08  
 Prepared by

Coordinating Person

Approved by

**SOORTY ENTERPRISES (PRIVATE) LIMITED**  
**WORK ORDER**



Date : 31-May-2023

Order No SER2300521

Organization: 08

**Detail of Work to be Outsourced**

<b>Job Detail:</b> ELECTRICAL WORKS FOR R&D BUILDING EXTENSION								
<b>Coordinating Person's:</b>	SHERAZ AHMED							
<b>Designation:</b>	MANAGER ELECTRICAND AND ELECTRONICS							
<b>Contractor Name:</b>	A.E.A. INTERNATIONAL (PRIVATE) LIMITED (5412786-6)							
<b>Status :</b>	N/A							
<b>Expected Start Date</b>	<b>Expected date of completion</b>							
<b>Actual date of Completion</b>	<b>Material Provided by</b>							
<b>Mode of Payment:</b> Cheque	<b>Withholding Tax:</b> No							
<b>Payment Terms:</b> 50% ADVANCE & 50% AT THE TIME OF DELIVERY								
<b>SERVICE / LABOUR</b>								
<b>Description</b>	<b>DEPARTMENT</b>	<b>UOM</b>	<b>Quantity</b>	<b>Curr.</b>	<b>Price</b>	<b>S.Tax</b>	<b>S.T Amt</b>	<b>Amount</b>
CIP - CAPITAL WORK IN PROCESS - ELECTRICAL WORKS FOR R&D BUILDING EXTENSION	ELECTRIC - Denim Unit	num	1.00	PKR				
<b>Total Amount</b>								
<b>MATERIAL</b>								
<b>Description</b>	<b>UOM</b>	<b>Quantity</b>	<b>Curr.</b>	<b>Price</b>	<b>S.Tax %</b>	<b>S.T Amount</b>	<b>Amount</b>	
<b>Total Amount</b>								
<b>Estimated Cost of the Job</b>	<b>Material</b>	<b>Labour</b>	<b>Discount</b>	<b>Total</b>				

**Remarks** EAI  
 REF NO: AEA/05/2023#1042  
 DATED: MAY 18 2023

AMOUNT TO BE PAIDAS PER INVOICE: Rs.

pur03-u08

Prepared by

Coordinating Person

Approved by



**Artistic Garment Industries (AGI Denim) (Pvt.) Ltd.**  
 (Formerly Artistic Fabric and Garment Industries (Pvt) Ltd.)  
**MANUFACTURER & EXPORTER OF YARN, DENIM FABRICS & FASHION GARMENTS**

Plot #53,54,71,72 Sector 28, Korangi Industrial Area, Karachi  
 Phone: 92-2137132233/92-2135035501  
 GST: 12-02-6200-003-82, NTN: 0709709-3

Pcm/pur/4/009

Issue#01

Date:08-07-2008

**Standard Purchase Order(Internal)**

Supplier : Advance Engineering Associates  
 Address : Suite # 313 3rd Floor Arsam Estate Shahrah-e-Faisal  
 Muhammad Aslam Shestet Karachi PK  
 Phone : 021-34311985-6  
 PR No : 107047  
 PR Date : 26-DEC-22  
 Mottle :  
 Email : ae.associates@yahoo  
 N.T.N : 0775838-3  
 S.T.R.N :  
 Location :  
 Status: **APPROVED 28-DEC-22**

Supplier Terms : 60 Days  
 PO Number (0) : 213756  
 Purchase Order Date : 28-DEC-22  
 PR Approval Date : 26-DEC-22  
 Department : ELECTRICAL  
 Unit: (K2) AGI-2, Plot#71,72, Sector 28, KIA, Karachi Karachi  
 Bill To : AGI-2, Plot#71,72, Sector 28, KIA, Karachi Karachi  
 Department(Buyer) :  
 Creation Type : Auto Create  
 Project:  
 Project Description:

S.N	Prefix	Item Description	UOM	Qty.	Rate (PKR)	Disc	Tax Code	Net Rate(PKR)	Value (PKR)	Last Supplier	Last Purchase Price	Last Purchase Date	Last Purchase Qty	Last Purchase Unit	On Hand Qty
1	80000	L.V System for New Building at K-13	JOB	1.00		0.0000									0 @ K2
2	80000	ELV System for New Building at K-13	JOB	1.00		0.0000									0 @ K2
3	80000	Modification & Upgradation of Power House & Sub-Station at K-13	JOB	1.00		0.0000									0 @ K2

Total:            PKR

**TERMS & CONDITIONS:**

If GST Bill -Commercial Invoice will be sent after 5<sup>th</sup> of the following month, payment will be delayed.  
 Delivery Required Immediately  
 \*Your product should comply with Inditex Clear to Wear (CTW) Requirements 2019.  
 \*Goods included in this PO should be delivered in their original container, with their original labeling including product name, manufacturer/distributor name and chemical product lot/batch number  
 The Supplier raw material must fulfill RECH, MRSL and eeko-Tex Requirements.  
 MSDS, Certificate of analysis and MRSL compliance certificate is required with each delivery.

PAYMENT: 25 ADV 25 SUB DRAW 25 Prep Tend 25 Our EXCU OF W

REMARKS:  
 FOR A01-13 NEW BUILDING CONSULTANCY OF ELECTRICAL WORK & REQ.  
 107047.  
 Auditor's Note : CEO's Approval Attached

Item	Total
------	-------

\_\_\_\_\_  
 DANISH SHAKIR  
 Prepared by  
 Incharge

\_\_\_\_\_  
 Checked By  
 Audit Accounts

\_\_\_\_\_  
 WAQAR AHMED  
 Authorized By  
 HOD-GMTD

\_\_\_\_\_  
 Approved By  
 Director

Print By: JUNIAD KHAN  
 Print Date:12/26/2022 17:58 PM

Garment Division - K2/ AGI-2, Plot#71,72, Sector 28, KIA, Karachi Karachi  
 This is a System Generated Report & may not require Signatures

PO NUMBER: 213756  
 PDF Name: PO\_PUR\_ORDER\_BITER\_AFGI  
 Page 1 of 2



## Pakistan Synthetics Limited

Hub Industrial and Trading Estate.

F-1, 2, 3 Lasbella, 90250, Balochistan, Pakistan.

Phone: +92-853-363723; E-mail: Info@pslpet.com

Ref: PSL/D/2087/SGL/1121/1

November 21, 2022

To : **ADVANCE ENGINEERING ASSOCIATES**  
ELECTRICAL & MECHANICAL  
CONSULTING ENGINEER  
Suite # 313, 3<sup>rd</sup> Floor, Anum Estate  
Shahra-e-Faisal, Karachi.  
Tel: 34311985-6, Fax: 34311987.  
E-mail: ae.associates@yahoo.com

Subject : Modification Work in Existing System To Synchronize Gensets Located at  
Two Separate Power Houses

Please refer your Quotation No. AEA/B/0047# 8401 dated November 19, 2022, we are pleased to place order for Modification Work in Existing System to Synchronize Gensets Located at Two Separate Power Houses. as per below detail,

### Scope of Work:

#### Job Title:

1. Study and examine the existing Electrical distribution system and detail provided by PSL and define electrical works to be carried out to satisfy the system requirement.
2. Propose conceptual design with 2 to 3 options with Budgetary cost to synchronize existing Gensets located at two separate Power Houses.
3. Compute total electrical load requirement of existing system and advice means and method of availability of Power Source.
4. Develop detail design of proposed electrical scheme after finalization of any one option.
5. Prepare civil layout plan of Substation Room if required.
6. Propose sizing of Transformer, Low Voltage/High Voltage Cables, Switchgear Panels, Busways etc.
7. Selection of means and methods of Power Cables, Busways, Transformers etc.
8. Short Circuit Calculation for switchgear equipment.
9. Prepare Power cables/Busway Route Layout Plan.
10. Develop conceptual and detail design of Earthing, if required.
11. Designing of Load Management / Dumping of System.
12. Based on finally agreed design/ modification work of Electrical System, prepare final drawing (on AutoCAD format), T.S & B.O.Q (Quotation Documents).

**Time of Completion:** Delivery within 3 ~ 4 Weeks.

**Job Cost:** Rs. \_\_\_\_\_ := (rupees)

*(without any Tax)*

#### Payment Terms:

- 25% Advance with Work Order. (To be adjusted in Running bills).
- 25% on submission of conceptual drawings,
- 25% on submission of BOQ and Quotation Document.
- 25% during the execution of work.



## Pakistan Synthetics Limited

Hub Industrial and Trading Estate.

F-1, 2, 3 Lasbella, 90250, Balochistan, Pakistan.

Phone: +92-853-363723; E-mail: [Info@pslpet.com](mailto:Info@pslpet.com)

**Tax Exemption:** If you have any exemption of tax please share it with us, before payment.

**Mode of payment:** All payments will be made through crossed cheque in favor of M/s. Advance Engineering Associates, please provide detail of your bank account, such as account number, name of the bank and branch, on your company letter, for payment. Also provide copy of NTN Certificate of your company.

**Terms and conditions:** Standard terms and conditions for working with in PSL.

**Penalty Clause:** In case of delay of work, we have reserve rights to claim compensation.

If above conditions are accepted to you, please sign and affix your seal signifying your acceptance, on duplicate and return to us.

*for Pakistan Synthetics Limited*

**TANVEER MEHRAJ**  
**GENERAL MANAGER**



**ARTISTIC MILLINERS (PVT) LTD.**  
 Plot No. 2, Sector 25, Korangi Industrial Area, Karachi  
 Tel : (+9221) 111-263-646 Fax (+9221) 35074192-5

**AM-4 (Garments Division)**  
 SALES TAX # 17-50-5205-002-02  
 N.T.N. # 2645727-0

Auto, Create

**WORK ORDER**

PURCHASE ORDER MUST APPEAR ON DELIVERY CHALLAN, SALES TAX INVOICES & ANALYSIS REPORT WHERE APPLICABLE. MATERIAL SHOULD BE AS PER OUR APPROVED SPECIFICATION.		<b>P.O. NO.</b> : 134419	<b>PKR</b> REVISION 0
		<b>P.O. DATE</b> : 04-OCT-22	CONVERSION RATE: 1
		<b>PAYMENT TERM</b> : As per Agreement	
<b>TO, M/S</b> : ADVANCE ENGINEERING ASSOCIATES		<b>DELIVERY DATE</b> : 13-SEP-22	TOLERANCE 0 %
<b>ADDRESS</b> : KARACHI		<b>STATUS</b> : APPROVED	
<b>S.REG #</b> :		<b>DEPARTMENT</b> : Electrical	
<b>TEL NO.</b> :			
<b>PARTICULARS</b> : AM-04 POWER HOUSE UPGRADATION PR # 94601-			

S. #	REQ. NO.	REQ. DATE DEPT.	ITEM DESCRIPTION	UNIT	P.O. QTY.	RATE (Pak. Rs.)	AMOUNT EXCL. G.S.T.	Discount Amount	G.S.T. Rate	G.S.T. AMOUNT	AMOUNT INCL. G.S.T.
1			ELECTRICAL-DEPRECIATION - FACTORY EQUIPMENTS- EXPENSE	Job	1.00				13.00		
			CONSULTANCY FOR UPGRADATION WORK TO PROVIDE UNINTERRUPTED POWER SUPPLY TO CRITICAL LOAD & MODIFICATION WORK IN MAIN ELECTRICAL DISTRIBUTION SYSTEM OF NON-CRITICAL LOAD AS PER APPROVED PROPOSAL								
<b>Total :</b>											

**DISCOUNT** : 25.00%  
**INCOME TAX %** : 0.00%

Service Charges (Pak. Rs.)	0
Cartage (Pak. Rs.)	0
Income Tax (Pak. Rs.)	0
F.E.D. (Pak. Rs.)	0

**AMOUNT IN WORDS:**  
 Pak. Rupees

**GRAND TOTAL PKR:**

Rizwan Shahid  
 05-OCT-22 04:04:25 PM

Prepared By \_\_\_\_\_ Purchase Manager \_\_\_\_\_ General Manager \_\_\_\_\_



# International Textile Limited

Unit-2: Plot 12&27, Sector 20, Korangi Industrial Area, Karachi, Phone# 5043630-1, Fax# 5040755

URL: <http://www.internationaltextile.com>

NTN # 0913378-0, STRN # 12-02-5209-002-82

## Work Order-Local (Unit 2)

<b>To.</b>	180812 ADVANCE ENGINEERING ASSOCIATES	<b>Purchase Order #.</b>	9000112068
<b>Address</b>	3RD FLOOR ANUM ESTATE SHAHRAH-E-FAISAL,	<b>Order Date.</b>	23.06.2022
<b>Tel</b>	021-34311985	<b>Payment Term</b>	Due after 30 days
<b>Fax</b>		<b>Purchase Group</b>	205-Services
		<b>Print Date &amp; Time.</b>	23.06.2022 15:47:49

S.No	Material	Material Description	Qty	Rate	Net Value	GST%	GST Amount	Extra GST	Total Cost
1		Project supervision & implementation PR# 8000129604 10 Vendor: Advance Engineering Project supervision and implementation charges for 2.5MW K-electric H.T & L.T connection with existing system.							
1.1	1000180	ITL CONSULTANCY SERVICES - Shared Services / Power house Off Delivery Date 05.07.2022 Vendor: Advance Engineering Project supervision and implementation charges for 2.5MW K-electric H.T & L.T connection with existing system.  Extra Tax %. Labour Charges Transportation Chrg	1 AU	/1 LE		0.00	0.00	0.00	
<b>Total:</b>								0.00	

### Amount in Words:

**IMPORTANT NOTE: PLEASE DON'T FORGET TO MENTION OUR PURCHASE ORDER NUMBER ON DELIVERY CHALLAN AND G.S.T .PLEASE BE NOTED WITHOUT PURCHASES ORDER NUMBER WE WOULD NOT BE ABLE TO RECEIVE THE DELIVERY.**

Note:

Please supply to Terms & Conditions as specified herein material/service described above & Consign to Store Incharge, International Textile Limited, along with immediate invoice/bill after final delivery of these items It is mandatory to mention this PO number on the relevant invoices & Delivery Chalan(s) submitted against this PO and the same Material Description and Material Codes should reflect on your Delivery Chalan and Bills/Invoices as mentioned herein. In view of current amendment in Sales Tax Law HS Code of your items being supplied should also be mentioned on your invoice. Non-compliance of these guidelines may result in payment delays for which the responsibility would remain solely with the supplier.

Income Tax & GST would be withheld as per law. If you are exempt must attach copy of such exemption certificate with your GST/Invoice.

In case of any quality, safety & legality issue identified in items ITL may keep rights to hold production or may cancel orders & send back goods to supplier with mutual agreement.

For International Textile Limited

Manager Procurement

Generated by:



NOTE: This is a system generated P.O. which does not require a signature.

# Artistic Denim Mills Limited

Plot No. 5-9,23-26 Sector 16,  
Korangi Industrial Area  
Karachi Sindh, Pakistan.

**Phone:** +92-111-236-236

**Fax:** +92-21-35054652

**NTN:** 0704132-2

**GST No:** 12-02-5209-003-91

**Email:** email@admdenim.com

## WORK ORDER

The following number must appear on all related correspondence, shipping papers, and invoices.

**W.O. Number:** WO-00094368

**W.O. Date:** 17-Jun-2022

**Requested By:** Spinning SP

### TO:

**Name:** Advance Engineering Associates

**Address:** Suit # 313, 3rd Floor, Anum Estate Shakra-e-Faisal, Karachi Sindh Pakistan.

**Phone:** 021-34311985-6

**Fax:**

**NTN:** 0775838-3

**GST No:**

**Email:** Ae.associates@yahoo.com

**CNIC:** -

### SHIP TO:

**Company:** Artistic Denim Mills Limited

**Address:** Plot No. 5-9,23-26 Sector 16, Korangi Industrial Area Karachi Sindh, Pakistan.

**Phone:** +92-111-236-236

**Email:** electrical@admdenim.com

Delivery Date	Terms Of Payment	Category	Orderer	Mode of Delivery	Service Terms
17-Jun-2022	25% Adv	Maintenance	Rizwan Arshad	House Job	Urgent

S.No.	Item ID	Description	Department	Style	Color	Size	Quantity	Unit	Unit Price (PKR)	Total (PKR)
1	S00086282 CWIP. Serv	Consultancy Charges For 4.9 M.W K-Electric Connection Enhancement Up-Grading Modification Power Distribution System	Singer Plot				1.00	job		

### Terms and Conditions

- Enter this order in accordance with the prices, terms, service method and specifications listed above.
- Please notify us immediately if you are unable to service as specified.

Send all correspondence to:  
Artistic Denim Mills Limited

DISCOUNT 0%	0.00
AFTER DISCOUNT	
SALES TAX	0.00
FREIGHT	0.00
OTHER	0.00
<b>TOTAL PKR</b>	

### NOTES

- \* Quotation Number, AEA/B/0047#8287
- \* Invoice Number,

### A- SCOPE OF SERVICES :

- Study and examine the Existing Electrical Distribution System of your factory for adding 4.9 M.W K-Electric connection for system up-gradation and synchronizing with Gas. Gen. Sets. (If required)
- Inspection of existing MV and LV Electrical Network (Electrical Distribution Panels, Feeders, and Transformers).
- Compute total electrical load & distribute according to the system requirement to reduce power losses.



**Artistic Garment Industries (AGI Denim) (Pvt.) Ltd.**  
(Formerly Artistic Fabric and Garment Industries (Pvt) Ltd.)  
**MANUFACTURER & EXPORTER OF YARN, DENIM FABRICS & FASHION  
GARMENTS**

Plot #53,54,71,72 Sector 28, Korangi Industrial Area, Karachi  
Phone: 92-2137132233/92-2135035501  
GST: 12-02-6200-003-82, NTN: 0709709-3

Pcm/pur/4/009  
Issue#01  
Date:08-07-2008

**Standard Purchase Order**

Supplier Code : 1273  
Supplier: Advance Engineering Associates  
Address: Suite # 313 3rd Floor Anum Estate  
Shahrah-e-Faisal Muhammad Aslam  
Shelot Karachi PK  
Phone: 021-34311985-6  
Mobile:  
Email: ae.associates@yahoo  
N.T.N: 0775838-3  
S.T.R.N :  
Location:  
Unit Name : Garment Division - M1  
Status: **APPROVED**  
Customer Name:  
Customer PO:

PO Number(0): 199640  
Purchase Order Date: 07-JUN-22  
Department: ELECTRICAL  
Project:  
Unit: (M1)  
Bill To: AGI-Malir, Plot No. 4510 & 11, Malir Industrial Area,  
Karachi, Karachi  
39/A, Block 6, P.E.C.H.S, Shahrah-e-Faisal Karachi  
Department(Buyer):  
Job #  
Creation Type : Auto Create  
Division:  
Style:

S.NO	Prefix	Item Description	UOM	Quantity	Rate (PKR)	DISCOUNT	Tax Code	Net Rate (PKR)	Value (PKR)
1	80000	CONSULTANCY PROPOSAL FOR 1.6 MW KE CONNECTION LOAD AT AGI MALIR UNIT M1 M2 M3 M4 KARACHI	JOB	1.00		0.0000			

**Total:**

**TERMS & CONDITIONS:**

If GST/Bill /Commercial Invoice will be sent after 5<sup>th</sup> of the following month, payment will be delayed  
Delivery Required Immediately  
PAYMENT: 25 ADV 25 SUB DRAW 25 Prep Tend/Q 25 Dur EXCU OF W

**REMARKS:**

REQUIRED FOR MALIR ALL UNITS

RAMISH KHAN

Prepared by  
Incharge

Checked By  
Audit/Accounts

WAQAR AHMED

Authorized By  
HO/TD/GM

Approved By  
Director

Print By: ASHHAD HUSSAIN  
Print Date: 6/8/2022 10:00 AM

RDF Name: PO\_PURCHASE\_ORDER  
Page 1 of 1

Head Office/ AGI-Malir, Plot No. 4510 & 11, Malir Industrial Area, Karachi, Karachi

# Artistic Denim Mills Limited

ADM-STR-031

Plot No. 5-9,23-26 Sector 16,  
Korangi Industrial Area  
Karachi Sindh, Pakistan.

**Phone:** +92-111-236-236

**Fax:** +92-21-35054652

**NTN:** 0704132-2

**GST No:** 12-02-5209-003-91

**Email:** email@admdenim.com

## WORK ORDER

The following number must appear on all related correspondence, shipping papers, and invoices.

**W.O. Number:** WO-00094339

**W.O. Date:** 16-Jun-2022

**Requested By:** Garments

### TO:

**Name:** Advance Engineering Associates

**Address:** Suit # 313, 3rd Floor, Anum Estate Shakra-e-Faisal, Karachi Sindh Pakistan..

**Phone:** 021-34311985-6

**Fax:**

**NTN:** 0775838-3

**GST No:**

**Email:** Ae.associates@yahoo.com

**CNIC:**

### SHIP TO:

**Company:** Artistic Denim Mills Limited

**Address:** Plot No. 5-9,23-26 Sector 16,  
Korangi Industrial Area Karachi Sindh,  
Pakistan.

**Phone:** +92-111-236-236

**Email:** electrical@admdenim.com

Delivery Date	Terms Of Payment	Category	Orderer	Mode of Delivery	Service Terms
16-Jun-2022	25% Adv	Electrical	Rizwan Arshad	House Job	Urgent

S.No.	Item ID	Description	Department	Style	Color	Size	Quantity	Unit	Unit Price (PKR)	Total (PKR)
1	S00086283 CWIP. Serv	Consultancy Charges For 3.9 M.W K-Electric Connection Enhancement Up-Grading Modification Power Distribution System	ADM-3 (New building)				1.00	job		

### Terms and Conditions

1. Enter this order in accordance with the prices, terms, service method and specifications listed above.
2. Please notify us immediately if you are unable to service as specified.

Send all correspondence to:  
Artistic Denim Mills Limited

DISCOUNT 0%	0.00
AFTER DISCOUNT	
SALES TAX	0.00
FREIGHT	0.00
OTHER	0.00
TOTAL PKR	



**Artistic Garment Industries (AGI Denim) (Pvt.) Ltd.**  
 (Formerly Artistic Fabric and Garment Industries (Pvt) Ltd.)  
 MANUFACTURER & EXPORTER OF YARN, DENIM FABRICS & FASHION GARMENTS  
 Plot #53,54,71,72 Sector 28, Korangi Industrial Area, Karachi  
 Phone: 92-2137132233/92-2135035501  
 GST: 12-02-6200-003-82, NTN: 0709709-3

PCM/PUR/4/009  
 Issue#02  
 Date:11-06-2019

**Standard Purchase Order**

Supplier Code :	1273	PO Number(0):	38350
Supplier:	Advance Engineering Associates	Purchase Order Date:	09-JUN-22
Address:	Suite # 313 3rd Floor Anum Estate Shahrah-e-Faisal Muhammad Aslam Shelot Karachi PK 021-34311985-6	Department:	POWER HOUSE
Phone:	021-34311985-6	PR No	19167
PR Date:	10-MAY-22	PR Approval Date:	10-MAY-22
Mobile:		Project:	CWIP-100
Email:	ae.associates@yahoo	Unit: (DM1)	Plot No. 14, Survey No. 16, 17, Deh Khando, Bin Qasim Town, Main National HighwayKarachi
N.T.N:	0775838-3	Bill To:	Plot No. 14, Survey No. 16, 17, Deh Khando, Bin Qasim Town, Main National HighwayKarachi
S.T.R.N :		PI Number:	
Location:	DM1	Department(Buyer):	MAIN STORE
Unit Name :	AGI Denim Mill	Job #	
Status:	APPROVED 15-JUN-22	Creation Type :	Auto Create

S.#	Prefix	Item Description	Detail /	Need by Date	UOM	Qty	Rate (PKR)	DISC	Tax Code	Net Rate (PKR)	Value (PKR)
1	80000	Service Charges	Consultancy Fees for MTU Gas Engine	15-JUN-22	JOB	1.00		0.00	INPUT SRB @ 13%		

**Total:** PKF

Note 1 Invoice will must be submit to Accounts Dept in Seven days after complete the delivery.

**TERMS & CONDITIONS:**

If GST/Bill /Commercial invoice will be sent after 5<sup>th</sup> of the following month, payment will be delayed  
 Delivery Required Immediately  
 All goods must be comply with latest version of inditex CTW & MRSL.  
 All goods delivery must be in original container & original labels include with product name, manufacturing name and Lot # on it.  
 PAYMENT: 50%adv,remain pay as per quotation pay schedule.

**REMARKS:**

LC/TT/IFD/BC/FOC # :

M.SHEHROZ

Prepared by  
Incharge

YAWAR ANSARI

Checked By  
Audit/Accounts

SCM.RIAZLADHA

Authorized By  
HO/TD/GM

Approved By  
Director



# International Textile Limited

Unit-2: Plot 12&27, Sector 20, Korangi Industrial Area, Karachi, Phone# 5043630-1, Fax# 5040755

URL: <http://www.internationaltextile.com>

NTN # 0913378-0, STRN # 12-02-5209-002-82

## Work Order-Local (Unit 2)

<b>To.</b>	180812 ADVANCE ENGINEERING ASSOCIATES	<b>Purchase Order #.</b>	9000110600
<b>Address</b>	3RD FLOOR ANUM ESTATE SHAHRAH-E-FAISAL,	<b>Order Date.</b>	27.05.2022
<b>Tel</b>	021-34311985	<b>Payment Term</b>	Due after 30 days
<b>Fax</b>		<b>Purchase Group</b>	205-Services
		<b>Print Date &amp; Time.</b>	27.05.2022 11:25:52

S.No	Material	Material Description	Qty	Rate	Net Value	GST%	GST Amount	Extra GST	Total Cost
1		<b>Consultancy Charges Design/drawing</b> PR# 8000128009 10 Vendor: Advance Engineering Associates Consultancy Charegs of drawing/design and layout of 2.5MW KE coonection Approved quotation attached with MD Approval.							
1.1	1000034	TTL Machine Repair & Maintenance Service - Shared Services / Power house Off Delivery Date 10.06.2022 Vendor: Advance Engineering Associates Consultancy Charegs of drawing/design and layout of 2.5MW KE coonection Approved quotation attached with MD Approval. 25% Advance Payment.  Labour Charges Transportation Chrg Extra Tax %.	1 AU	/1 LE		0.00	0.00	0.00	
									0.00
									0.00
									0.00
<b>Total:</b>									0.00

Amount in Words:

**IMPORTANT NOTE: PLEASE DON'T FORGET TO MENTION OUR PURCHASE ORDER NUMBER ON DELIVERY CHALLAN AND G.S.T. PLEASE BE NOTED WITHOUT PURCHASES ORDER NUMBER WE WOULD NOT BE ABLE TO RECEIVE THE DELIVERY.**

Note:

Please supply to Terms & Conditions as specified herein material/service described above & Consign to Store Incharge, International Textile Limited, along with immediate invoice/bill after final delivery of these items It is mandatory to mention this PO number on the relevant invoices & Delivery Chalan(s) submitted against this PO and the same Material Description and Material Codes should reflect on your Delivery Chalan and Bills/Invoices as mentioned herein. In view of current amendment in Sales Tax Law HS Code of your items being supplied should also be mentioned on your invoice. Non-compliance of these guidelines may result in payment delays for which the responsibility would remain solely with the supplier.

Income Tax & GST would be withheld as per law. If you are exempt must attach copy of such exemption certificate with your GST/Invoice.

In case of any quality, safety & legality issue identified in items TTL may keep rights to hold production or may cancel orders & send back goods to supplier with mutual agreement.

For International Textile Limited

Manager Procurement

Generated by:



NOTE: This is a system generated P.O. which does not require a signature.

## **Shabbir Tiles & Ceramics Limited**

15th Mile Stone, National Highway, Landhi, Karachi-75120

Phone No. 5015024-25, Fax No. 5015545

S.Tax Reg. # 02-04-6907-001-37

### **ADVANCE ENGINEERING ASSOCIATES**

BillTo .

Phone :

Your Ref No. :

Ref No. : 2910673

Order Date : 28.04.2022

Delivery Date : 05.05.2022

### **Job Order -**

Kindly arrange to Supply/Manufacture/Process the Goods/Items as per term and condition mentioned here.

#	Description	Quantity	Rate	Sales Tax	Total Payment Due
1	Consultancy charges for HFO based Generation in Shabbir Tiles both units	1		11	PKP

Total ==> \_\_\_\_\_

Total Rupees ==> \_\_\_\_\_

Payment shall be made after completion of Job

100% Advance

( Adjusted on Running Bills)

25% on submission of conceptual drawings

25% on Engineering estimates

25% on Tender Doc

25% on execution of work

Thank you for your co-operation

for SHABBIR TILES & CERAMICS LTD

Created on: 28.04.2022

\_\_\_\_\_  
DEPARTMENT'S MANAGER



**Artistic Garment Industries (AGI Denim) (Pvt.) Ltd.**  
(Formerly Artistic Fabric and Garment Industries (Pvt) Ltd.)  
MANUFACTURER & EXPORTER OF YARN, DENIM FABRICS & FASHION GARMENTS  
Plot #53,54,71,72 Sector 28, Korangi Industrial Area, Karachi  
Phone: 92-2137132233/92-2135035501  
GST: 12-02-6200-003-82, NTN: 0709709-3

PCM/PUR/4/009  
Issue#02  
Date:11-06-2019

**Standard Purchase Order**

Supplier Code : 1273 PO Number(0): 37683  
Supplier: Advance Engineering Associates Purchase Order Date: 15-APR-22  
Address: Suite # 313 3rd Floor Anum Estate Department: POWER HOUSE  
Shahrah-e-Faisal Muhammad Aslam  
Shelot Karachi PK  
Phone: 021-34311985-6 PR No 18925  
PR Date: 15-APR-22 PR Approval Date: 15-APR-22  
Mobile: Project:  
Email: ae.associates@yahoo Unit: (DM1) Plot No. 14, Survey No. 16, 17, Deh Khando, Bin Qasim  
Town, Main National HighwayKarachi  
N.T.N: 0775838-3 Bill To: Plot No. 14, Survey No. 16, 17, Deh Khando, Bin Qasim  
Town, Main National HighwayKarachi  
S.T.R.N : PI Number:  
Location: DM1 Department(Buyer): MAIN STORE  
Unit Name : AGI Denim Mill Job #  
Status: IN PROCESS Creation Type : Auto Create

S.#	Prefix	Item Description	Detail /	Need by Date	UOM	Qty	Rate (PKR)	DISC	Tax Code	Net Rate (PKR)	Value (PKR)
1	80000	Service Charges	of Consultancy Proposal for 2.5 to 5 M.W K-Electric Connection for System Upgradation at AGI-Denim	16-APR-22	JOB	1.00		0.00	INPUT SRB @ 13%		

**Total:** PKF

Note : Invoice will must be submit to Accounts Dept in Seven days after complete the delivery.

**TERMS & CONDITIONS:**

If GST/Bill /Commercial Invoice will be sent after 5<sup>th</sup> of the following month, payment will be delayed  
Delivery Required Immediately  
All goods must be comply with latest version of inditex CTW & MRSL  
All goods delivery must be in original container & original labels include with product name, manufacturing name and Lot # on it.  
PAYMENT: 25 ADV 25 SUB DRAW 25 Prep Tend/Q 25 Dur EXCU OF W

**REMARKS:**

LC/TT/IFDBC/FOC # :

M.SHEHROZ

Prepared by  
Incharge

Checked By  
Audit/Accounts

Authorized By  
HO/TD/GM

Approved By  
Director



**Artistic Garment Industries (AGI Denim) (Pvt.) Ltd.**  
 (Formerly Artistic Fabric and Garment Industries (Pvt) Ltd.)  
 MANUFACTURER & EXPORTER OF YARN, DENIM FABRICS & FASHION  
 GARMENTS

Plot #53,54,71,72 Sector 28, Korangi Industrial Area, Karachi  
 Phone: 92-2137132233/92-2135035501  
 GST: 12-02-6200-003-82, NTN: 0709709-3

Pcm/pur/4/009

Issue#01

Date:08-07-2008

**Standard Purchase Order(Internal)**

Supplier : Advance Engineering Associates  
 Address : Suite # 313 3rd Floor Anum Estate Shahrah-e-Faisal  
 Muhammad Aslam Shelot Karachi PK

Supplier Terms : 60 Days  
 PO Number (0) : 461

Phone :  
 PR No : 342  
 PR Date : 13-APR-22

Purchase Order Date : 15-APR-22

Mobile :  
 Email :

PR Approval Date : 13-APR-22  
 Department : POWER HOUSE  
 Unit: (APD) Plot Survey # 31-36 Tappo Landhi, Bin Qasim Town,  
 District Malir, KarachiKarachi  
 Bill To : 39/A, Block 6, P.E.C.H.S, Shahrah-e-FaisalKarachi

N.T.N : 0775838-3

S.T.R.N :

Department(Buyer) :

Location :  
 Status: **IN PROCESS Delivery  
 against an approved  
 purchase order is upon  
 supplier Risk**

Creation Type : Auto Create  
 Project: CWIP-0074  
 Project Description: Wartsila For Power House

N	Prefix	Item Description	UOM	Qty.	Rate (PKR)	Disc	Tax Code	Net Rate(PKR)	Value (PKR)	Last Supplier	Last Purchase Price	Last Purchase Date	Last Purchase Qty	Last Purchase Unit	On Hand Qty
1	80000	Consultancy proposal for KE Connection (Denim 02)	JOB	1.00		0.0000		UU							0.00 AF

Total: PKR

**TERMS & CONDITIONS:**

If GST/Bill /Commercial Invoice will be sent after 5<sup>th</sup> of the following month, payment will be delayed  
 Delivery Required Immediately

\*Your product should comply with Inditex Clear to Wear (CTW) Requirements 2010.

\*Goods included in this PO should be delivered in their original container, with their original labeling including product name, manufacturer/distributor name and chemical product lot/batch number

The Supplier raw material must fulfill RECH, MRSL and oeko-Tex Requirements.

MSDS, Certificate of analysis and MRSL compliance certificate is required with each delivery.

PAYMENT: 25 ADV 25 SUB DRAW 25 Prep Tend/Q 25 Dur EXCU OF W

**REMARKS:**

KE supply to Denim-02  
 Auditor's Note :

Item	Total
Total	0

Date	Auditor	Remarks
------	---------	---------

RAMISH KHAN  
 Prepared by  
 Incharge

Checked By  
 Audit/Accounts

SCM.RIAZLADHA  
 Authorized By  
 HOD/GM/TD

Approved By  
 Director



# ARTISTIC MILLINERS (PVT) LTD.

Plot No. 21,23 & 30 SECTOR - 25 , Korangi Industrial Area , Karachi

Tel : (+9221) 111-263-646 Fax : (+9221) 35075446

AM-14 (Garments Division)

SALES TAX # 17-50-5205-002-82  
N.T.N. # 2645727-0

Auto, Create

## WORK ORDER

PURCHASE ORDER MUST APPEAR ON DELIVERY CHALLAN, SALES TAX INVOICES & ANALYSYS REPORT WHERE APPLICABLE, MATERIAL SHOULD BE AS PER OUR APPROVED SPECIFICATION.

P.O. NO. : **35813** PKR REVISION : **0**

P.O. DATE : **07-MAR-22** CONVERSION RATE : **1**

PAYMENT TERM : **30% ADVANCE, 30% AFTER BILLING & C/L**

TO, M/S : **ADVANCE ENGINEERING ASSOCIATES**

ADDRESS : **KARACHI**

S.REG # : N.T.N # : **0775838-3**

TEL NO. : CONTACT PERSON :

DELIVERY DATE : **25-FEB-22** TOLERANCE : **0%**

STATUS : **INCOMPLETE**

DEPARTMENT : **Administration**

PARTICULARS: **CONSULTANCY SERVICES OF ELECTRICAL WORK, CHAIRMAN'S APPROVAL ATTACHED.**

S. #	REQ. NO.	REQ. DATE	REQ. DEPT.	ITEM DESCRIPTION	UNIT	P.O. QTY.	RATE (Pak. Rs.)	AMOUNT EXCL. G.S.T.	Discount Amount	G.S.T. Rate	G.S.T. AMOUNT	AMOUNT INCL. G.S.T.
1	None-COST OF EXPENSE		GOODS SOLD-	consultancy service of electrical works of am14 Extension	Job	1.00				0.00	0	
<b>Total :</b>												0.00

DISCOUNT : **23.11%**

INCOME TAX % : **0.00%**

AMOUNT IN WORDS-  
Pak. Rupees

Service Charges (Pak. Rs.)	0
Cartage (Pak. Rs.)	0
Income Tax (Pak. Rs.)	0
F.E.D. (Pak. Rs.)	0

GRAND TOTAL PKR: \_\_\_\_\_

Prepared By

Purchase Manager

Group Purchase Manager

General Manager



**Artistic Garment Industries (AGI Denim) (Pvt.) Ltd.**  
 (Formerly Artistic Fabric and Garment Industries (Pvt) Ltd.)  
 MANUFACTURER & EXPORTER OF YARN, DENIM FABRICS & FASHION  
 GARMENTS

Plot #53,54,71,72 Sector 28, Korangi Industrial Area, Karachi  
 Phone: 92-2137132233/92-2135035501  
 GST: 12-02-6200-003-82, NTN: 0709709-3

Pcm/pur/4/009  
 Issue#01  
 Date:08-07-2008

**Standard Purchase Order(Internal)**

Supplier : Advance Engineering Associates  
 Address : Suite # 313 3rd Floor Anum Estate Shahrah-e-Faisal  
 Muhammad Aslam Shelot Karachi PK  
 Phone : 021-34311985-6  
 PR No : 95957  
 PR Date : 05-MAR-22  
 Mobile :  
 Email : ae.associates@yahoo  
 N.T.N : 0775838-3  
 S.T.R.N :  
 Location :  
 Status: **APPROVED 08-MAR-22**

Supplier Terms : 60 Days  
 PO Number (0) : 193376  
 Purchase Order Date : 05-MAR-22  
 PR Approval Date : 05-MAR-22  
 Department : ELECTRICAL  
 Unit: (K2) AGI-2, Plot#71,72, Sector 28, KIA, Karachi.Karachi  
 Bill To : AGI-2, Plot#71,72, Sector 28, KIA, Karachi.Karachi  
 Department(Buyer) :  
 Creation Type : Auto Create  
 Project:  
 Project Description:

N	Prefix	Item Description	UOM	Qty.	Rate (PKR)	Disc	Tax Code	Net Rate(PKR)	Value (PKR)	Last Supplier	Last Purchase Price	Last Purchase Date	Last Purchase Qty	Last Purchase Unit	On Hand Qty
1	80000	Consultancy for 4MW KE Connection for Load Enhancement , Up-gradation & Modification of Existing Power Distribution at Unit K-2 & 5	JOB	1.00		0.0000		00							0 @

Total: \_\_\_\_\_  
 PKR

**TERMS & CONDITIONS:**

If GST/Bill /Commercial Invoice will be sent after 5<sup>th</sup> of the following month, payment will be delayed  
 Delivery Required Immediately  
 \*Your product should comply with Inditex Clear to Wear (CTW) Requirements 2010.  
 \*Goods included in this PO should be delivered in their original container, with their original labeling including product name, manufacturer/distributor name and chemical product lot/batch number  
 The Supplier raw material must fulfill RECH, MRSL and oeko-Tex Requirements.  
 MSDS, Certificate of analysis and MRSL compliance certificate is required with each delivery.

PAYMENT: 25 ADV 25 SUB DRAW 25 Prep Tend/Q 25 Dur EXCU OF W

**REMARKS:**  
 FOR K-ELECTRICAL CONNECTION FOR LOAD ENHANCEMENT & UP-GRADATION WORK & REQ.

95957.  
 Auditor's Note : CEO's Approval Attached

Item	Total
Total	0

DANISH SHAKIR

Prepared by  
 Incharge

Checked By  
 Audit/Accounts

WAQAR AHMED

Authorized By  
 HOD/IGM/TD

Approved By  
 Director

Print By: WAHAB.RAKHSHANI  
 Print Date:3/9/2022 13:02 PM

Garment Division - K2/ AGI-2, Plot#71,72, Sector 28, KIA, Karachi.Karachi

PO NUMBER: 193376  
 RDF Name:PO\_PUR\_ORDER\_INTER\_AFG  
 Page 1 of 2



**ARTISTIC MILLINERS (PVT) LTD.**  
 Plot # LF-32 & 33 , Landhi, Bin Qasim Town , Karachi  
 Tel : 021-38658950 Fax :

<b>ART MILL</b>	
SALES TAX #	17-50-5295-002-82
N.T.N. #	2845727-0

Rehman, Mr. Ikram Ur

**WORK ORDER**

PURCHASE ORDER MUST APPEAR ON DELIVERY CHALLAN, SALES TAX INVOICES & ANALYSIS REPORT WHERE APPLICABLE. MATERIAL SHOULD BE AS PER OUR APPROVED SPECIFICATION.		P.O. NO. : 3967	PKR	REVISION : 0
		P.O. DATE : 24-FEB-22	CONVERSION RATE: 1	
TO, M/S : ADVANCE ENGINEERING ASSOCIATES		PAYMENT TERM : 30% Advance Balance Against Working Bill		
ADDRESS : KARACHI,		DELIVERY DATE : 24-FEB-22	TOLERANCE : 0%	
S.REG # :	N.T.N # : 0775838-3	STATUS : APPROVED		
TEL NO. :	CONTACT PERSON :	DEPARTMENT :		
PARTICULARS: REQUIRED FOR UTILITIES-				

S. #	REQ. NO.	REQ. DATE	DEPT.	ITEM DESCRIPTION	UNIT	P.O. QTY.	RATE (Pak. Rs.)	AMOUNT EXCL. G.S.T.	Discount Amount	G.S.T. Rate	G.S.T. AMOUNT	AMOUNT INCL. G.S.T.
1				CONSULTANCY PROPOSAL FOR 4.7 MW K-ELECTRIC CONNECTION FOR LOAD ENHANCEMENT & UP-GRADATION / MODIFICATION OF EXISTING POWER DISTRIBUTION SYSTEM AT ARTMILL AM-16 ( DETAIL ARE ATTACHED )	Each	1.00			0.00	0.00	0	
<b>Total :</b>								1,500,000.00	0.00		0.00	1,500,000.00

DISCOUNT : 0.00%  
 INCOME TAX % : 3.00%

Service Charges (Pak. Rs.)	0
Cartage (Pak. Rs.)	0
Income Tax (Pak. Rs.)	
F.E.D. (Pak. Rs.)	0

AMOUNT IN WORDS:  
 Pak. Rupees \_\_\_\_\_

GRAND TOTAL PKR: \_\_\_\_\_

Shajeeel Ahmed  
 24-FEB-22 12:08:11 PM

Prepared By \_\_\_\_\_ Group Purchase Manager \_\_\_\_\_ Director Operations \_\_\_\_\_

**SOORTY ENTERPRISES (PRIVATE) LIMITED**  
**WORK ORDER**



Date : 16-Feb-2022

Order No SER2200055

Organization: 08

**Detail of Work to be Outsourced**

<b>Job Detail:</b>	Consultancy Proposal for Electrical Work of 120 Looms (Phase-I), Chemical Store, Rope Dyeing							
<b>Coordinating Person's:</b>	Mr. Alam Mazhari							
<b>Designation:</b>	COO Denim							
<b>Contractor Name:</b>	ADVANCE ENGINEERING ASSOCIATES (0775838-3)							
<b>Status :</b>	N/A							
<b>Expected Start Date</b>	<b>Expected date of completion</b>			<b>Actual date of Completion</b>			<b>Material Provided by</b>	
16-Feb-2022	16-Feb-2022							
<b>Mode of Payment:</b> Cheque	<b>Withholding Tax:</b> Yes			<b>Payment Terms:</b> ADVANCE PAYMENT				
<b><u>SERVICE / LABOUR</u></b>								
<b>Description</b>	<b>DEPARTMENT</b>	<b>UOM</b>	<b>Quantity</b>	<b>Curr.</b>	<b>Price</b>	<b>S.Tax</b>	<b>S.T Amt</b>	<b>Amount</b>
CIP - CAPITAL WORK IN PROCESS	WEAVING PRODUCTION 3 - Denim Unit	num	1.00	PKR				
<b>Total Amount</b>								
<b><u>MATERIAL</u></b>								
<b>Description</b>	<b>UOM</b>	<b>Quantity</b>	<b>Curr.</b>	<b>Price</b>	<b>S.Tax %</b>	<b>S.T Amount</b>	<b>Amount</b>	
<b>Total Amount</b>								
<b>Estimated Cost of the Job</b>	<b>Material</b>	<b>Labour</b>	<b>Discount</b>			<b>Total</b>		

**Remarks** Consultancy Proposal for Electrical Work of 120 Looms (Phase-I), Chemical Store, Rope Dyeing

- Payment Term:  
 - 25% Advance  
 - 25% on Submission of Conceptual Drawings  
 - 25% Preparation of Tender/ Quotation Documents  
 - 25% during execution of work

pur04-u08

Prepared by

Coordinating Person

Approved by



# CONTINENTAL BISCUITS LTD.



Floor # 12, Q.M. Building, Plot # BC-15, Block-7, KDA  
Scheme # 5, Clifton, Karachi.  
Phones: 9221-111-771-771, Fax9221-35147110

## PURCHASE ORDER

<b>Supplier M/s</b> ADVANCE ENGINEERING ASSOCIATES Suite # 313,3rd Floor, Anum Estate, Shahrah-e-faisal Karachi Karachi - P.O.Box:	<b>Purchase Order No</b> : 4500043239 <b>Purchase Order Date</b> : 09.02.2022 <b>Supplier Ref. Docs. No</b> <b>Payment Terms</b> : <b>GST# 01-02-1905-002-73 NTN # 0710106-6</b>
<b>Supplier NTN / CNIC:</b> 0775838-3 / 4220108580349	
<b>Delivery Address :</b> B-62, S.I.T.E. SHIKARPUR ROAD, SUKKUR	



Please arrange to supply the following:

Stock Code	Item Description	Unit	Price Per Unit	Quantity	Sales Tax	Value Excl. S.Tax	Delivery Date
	CONSULTANCY FOR 4.8MW WAPDA CONNECTION	AU		1.00	0.00		
	<b>GRAND TOTAL</b>				0.00		

Air Tickets, Transport, Food & Accomodation for 2 to 3 Engineers, at CBL End.

### Transporter Charges

<b>Remarks :</b> Payment Terms: Advance 25% against PDC, 25% on Conceptual Drawing, 25% on Tender Docs, 15% Execution of Work, 10% After Contractor Final Bill.	<b>Total Value Exclusive Taxes in PKR :</b> <b>Sales Tax Amount : 0.00</b> <b>Other Charges / Non-Claimable SED : 0.00</b> <b>Total Purchase Order Value in PKR :</b>
---	--

 <b>Signature</b>	 <b>Signature</b>	 <b>Finance Approval</b>	<b>SAROOSH BHATTI</b> Director COMMERCIAL CONTINENTAL BISCUITS LTD. <b>Director's Approval</b>
---	---	---	---

### Terms & Conditions :

- All items must be supplied as per specification & subject to approval of our quality control department at Sukkur Factory / Head Office.
- Upon receipt item must have a minimum one year shelf life.
- All invoices must be mailed or directly delivered to the Accounts department.
- PO number must appear on all delivery items, invoices and correspondence.



**ARTISTIC MILLINERS (PVT) LTD.**

Plot No. 471-472, Manzil Pump, Landhi, National Highway, Karachi

Tel : (+9221) 35001712-15 Fax : (+9221) 35001478

**AM-3 (Spinning Division)**SALES TAX # 17-58-5205-002-82  
N.T.N. # 2645727-0

Hassan, Mr. Syed Touseef

**WORK ORDER**

PURCHASE ORDER MUST APPEAR ON DELIVERY CHALLAN, SALES TAX INVOICES &amp; ANALYSIS REPORT WHERE APPLICABLE, MATERIAL SHOULD BE AS PER OUR APPROVED SPECIFICATION.

P.O. NO. : **16177** **PKR** REVISION **2**

P.O. DATE : 29-JAN-21 CONVERSION RATE: 1

PAYMENT TERM : 95 Advance, 5% M of Work, 20% After Completion of Work

TO, M/S : **ADVANCE ENGINEERING ASSOCIATES**ADDRESS : **KARACHI.**S.REG # : N.T.N # : **0775838-3**

TEL NO. : CONTACT PERSON :

DELIVERY DATE : TOLERANCE 0%

STATUS : **APPROVED**DEPARTMENT : **Power House**

PARTICULARS: REF NO. AEA/A004781 DT. 23-01-2021 CONSULTANCY SERVICE FOR K-ELECTRIC UPGRADEATION OF 4.7 MW.

S.#	REQ. NO.	REQ. DATE	REQ. DEPT.	ITEM DESCRIPTION	UNIT	P.O. QTY.	RATE (Pak. Rs.)	AMOUNT EXCL. G.S.T.	Discount Amount	G.S.T. Rate	G.S.T. AMOUNT	AMOUNT INCL. G.S.T.
1			CAL WORK-ASSETS	CONSULTANCY SERVICE FOR K-ELECTRIC UPGRADEATION OF 4.7 MW.	Each	1.00			0.00	10.00		
<b>Total :</b>									0.00			

DISCOUNT : **0.00%**INCOME TAX % : **0.00%**

AMOUNT IN WORDS:

Pak. Rupee

Service Charges (Pak. Rs.) **0**Cartage (Pak. Rs.) **0**Income Tax (Pak. Rs.) **0**F.E.D. (Pak. Rs.) **0**

GRAND TOTAL PKR: \_\_\_\_\_

Arif Khan

17-FEB-22 09:36:57 AM

Prepared By

Purchase Officer

Zafar Mehmood

17-FEB-22 10:11:08 AM

Accounts Manager

Baber Jadoon

17-FEB-22 10:25:10 AM

Director Spinning



**ARTISTIC MILLINERS (PVT) LTD.**  
 Plot No. 2, Sector 25, Korangi Industrial Area, Karachi  
 Tel : (+9221) 111-263-646 Fax : (+9221) 35074192-5

**AM-4 (Garments Division)**  
 SALES TAX # 17-50-5205-002-82  
 N.T.N. # 2645727-0

Shahid [Purchase], Mr. Rizwan

**WORK ORDER**

PURCHASE ORDER MUST APPEAR ON DELIVERY CHALLAN, SALES TAX INVOICES & ANALYSIS REPORT WHERE APPLICABLE. MATERIAL SHOULD BE AS PER OUR APPROVED SPECIFICATION.

P.O. NO. : **121891**      **PKR**      REVISION : **0**  
 P.O. DATE : 12-JAN-22      CONVERSION RATE: **1**  
 PAYMENT TERM : As per Agreement  
 DELIVERY DATE : 20-JAN-22      TOLERANCE : **0%**  
 STATUS : APPROVED  
 DEPARTMENT : Administration

TO, M/S : **ADVANCE ENGINEERING ASSOCIATES**

ADDRESS : KARACHI

S.REG # :      N.T.N # : 0775838-3

TEL NO. :      CONTACT PERSON :

PARTICULARS: REQUIRED FOR LT UPGRADEATION AND 4.7MW K.ELECTRIC POWER PR # 84131 (ELECTRICAL DEPT.)

S. #	REQ. NO.	REQ. DATE	ITEM DESCRIPTION	UNIT	P.O. QTY.	RATE (Pak. Rs.)	AMOUNT EXCL. G.S.T.	Discount Amount	G.S.T. Rate	G.S.T. AMOUNT	AMOUNT INCL. G.S.T.
1	COST OF GOODS SOLD-EXPENSE		Consultancy services for LT upgradeation and 4.7 MW k-electric power for system enhancement	Job	1.00				13.00		
<b>Total :</b>											

DISCOUNT : 25.00%  
 INCOME TAX % : 0.00%

Service Charges (Pak. Rs.) : 0  
 Cartage (Pak. Rs.) : 0  
 Income Tax (Pak. Rs.) : 0  
 F.E.D. (Pak. Rs.) : 0

AMOUNT IN WORDS:  
 Pak. \_\_\_\_\_

GRAND TOTAL PKR: \_\_\_\_\_

Rizwan Shahid [Purchase]  
 13-JAN-22 11:54:59 AM

Prepared By

Purchase Manager

General Manager

# Artistic Fabric and Garment Industries (Private) Limited

Manufacturer & Exporter of Denim Fabric & Ready Made Fashion Garments  
39/A Block 6 P.E.C.H.S, Shahra-e-Faisal, Karachi-75400 Pakistan  
UAN: (92-21)111004004, 34524411, 34524485  
GST: 12-02-6200-003-82, NTN: 0709709-3

PCM/PUR/4/009  
Issue#02  
Date:11-06-2019

## Standard Purchase Order

Supplier Code : 1273 PO Number(0): 355  
Supplier: Advance Engineering Associates Purchase Order Date: 17-DEC-21  
Address: Suite # 313 3rd Floor Anum Estate Department: POWER HOUSE  
Shahrah-e-Faisal Muhammad Aslam  
Shelot Karachi PK  
Phone: PR No 144  
PR Date: 15-OCT-21 PR Approval Date: 20-OCT-21  
Mobile: Project: CWIP-0074  
Email: Unit: (APD) Plot Survey # 31-36 Tappo Landhi, Bin Qasim Town,  
District Malir, KarachiKarachi  
N.T.N: 0775838-3 Bill To: 39/A, Block 6, P.E.C.H.S, Shahrah-e-FaisalKarachi  
S.T.R.N : PI Number:  
Location: AGI - K2 Department(Buyer): Purchase  
Unit Name : AGI Power Division Job #  
Status: IN PROCESS Creation Type : Auto Create

S.#	Prefix	Item Description	Detail /	Need by Date	UOM	Qty	Rate (PKR)	DISC	Tax Code	Net Rate (PKR)	Value (PKR)
1	79000	Consultancy Proposal for Wartsila Power House MCC Panel			JOB	1.00		0.00			

Total: PKR

Note: Invoice will must be submit to Accounts Dept in Seven days after complete the delivery.

### TERMS & CONDITIONS:

If GST/Bill /Commercial Invoice will be sent after 5<sup>th</sup> of the following month, payment will be delayed

Delivery Required Immediately

All goods must be comply with latest version of Inditex CTW & MRSL.

All goods delivery must be in original container & original labels include with product name, manufacturing name and Lot # on it.

PAYMENT: IMMEDIATE

### REMARKS:

PR# 144 -

LC/TT/FDBC/FOC # :

NABEEL\_ZIA

Prepared by  
Incharge

SCM.RIAZLADHA

Checked By  
Audit/Accounts

Authorized By  
HO/TD/GM

Approved By  
Director

Print By: NABEEL\_ZIA

Print Date:12/17/2021 14:45 PM

PDF Name:PO\_PURCHASE\_ORDER

Page 1 of

Head Office/ Plot Survey # 31-36 Tappo Landhi, Bin Qasim Town, District Malir, KarachiKarachi

# Artistic Fabric and Garment Industries (Private) Limited

Manufacturer & Exporter of Denim Fabric & Ready Made Fashion Garments  
39/A Block 6 P.E.C.H.S, Shahra-e-Faisal, Karachi-75400 Pakistan  
UAN: (92-21)111004004, 34524411, 34524485  
GST: 12-02-6200-003-82, NTN: 0709709-3

PCM/PUR/4/009  
Issue#02  
Date:11-06-2019

## Standard Purchase Order

Supplier Code : 1273 PO Number(0): 250  
Supplier: Advance Engineering Associates Purchase Order Date: 08-OCT-21  
Address: Suite # 313 3rd Floor Anum Estate Shahrah-e-Faisal Muhammad Aslam Shelet Karachi PK Department: ADMIN - CONSTRUCTIONS  
Phone: PR No 243  
PR Date: 08-OCT-21 PR Approval Date: 08-OCT-21  
Mobile: Project:  
Email: Unit: (DM2) Plot Survey # 31-36 Tappo Landhi, Bin Qasim Town, District Malir, KarachiKarachi  
N.T.N: 0775838-3 Bill To: 39/A, Block 6, P.E.C.H.S, Shahrah-e-FaisalKarachi  
S.T.R.N : PI Number:  
Location: Department(Buyer):  
Unit Name : AGI Denim Mill 2 Job #  
Status: INCOMPLETE Creation Type : Auto Create

S.#	Prefix	Item Description	Detail /	Need by Date	UOM	Qty	Rate (PKR)	DISC	Tax Code	Net Rate (PKR)	Value (PKR)
1	80000	Service Charges	Earthing & Lighting Protection SYSTEM		JOB	1.00		0.00			

Total: PKR

Note | Invoice will must be submit to Accounts Dept in Seven days after complete the delivery.

### TERMS & CONDITIONS:

If GST/Bill /Commercial Invoice will be sent after 5<sup>th</sup> of the following month, payment will be delayed

Delivery Required Immediately

All goods must be comply with latest version of inditex CTW & MRSL.

All goods delivery must be in original container & original labels include with product name, manufacturing name and Lot # on it.

PAYMENT:

### REMARKS:

payment Term # 50 % Advance 50% During Execution of Work -

LC/TT/IFDBC/FOC # :

WAQAR.ISHTIAQ

Prepared by  
Incharge

Checked By  
Audit/Accounts

Authorized By  
HO/TD/GM

Approved By  
Director

Print By: WAQAR.ISHTIAQ

Print Date:10/8/2021 17:15 PM

RDF Name:PO\_PURCHASE\_ORDER

Page 1 of

Head Office/ Plot Survey # 31-36 Tappo Landhi, Bin Qasim Town, District Malir, KarachiKarachi



# Artistic Fabric and Garment Industries (Private) Limited

Manufacturer & Exporter of Denim Fabric & Ready Made Fashion Garments

39/A Block 6 P.E.C.H.S, Shahra-e-Faisal, Karachi-75400 Pakistan

UAN: (92-21)111004004, 34524411, 34524485

GST: 12-02-6200-003-82, NTN: 0709709-3

Pcm/pur/4/009

Issue#02

Date:11-06-2019

## Standard Purchase Order

Supplier Code :	1273	PO Number(0):	176375
Supplier:	Advance Engineering Associates	Purchase Order Date:	06-JUL-21
Address:	Suite # 313 3rd Floor Anum Estate Shahrah-e-Faisal Muhammad Aslam Shelot Karachi PK	Department:	ELECTRICAL
Phone:	021-34311985-6	PR No	84942 , 84944
PR Date:	02-JUL-21	PR Approval Date:	02-JUL-21
Mobile:		Project:	
Email:	ae.associates@yahoo	Unit: (K2)	AGI-2, Plot#71,72, Sector 28, KIA, Karachi.Karachi
N.T.N:	0775838-3	Bill To:	39/A, Block 6, P.E.C.H.S, Shahrah-e-FaisalKarachi
S.T.R.N :		PI Number:	
Location:	AGI - K2	Department(Buyer):	Purchase
Unit Name :	Garment Division - K2	Job #	
Status:	IN PROCESS	Creation Type :	Auto Create

S.#	Prefix	Item Description	Detail /	Need by Date	UOM	Qty	Rate (PKR)	DISC	Tax Code	Net Rate (PKR)	Value (PKR)
1	80000	CONSULTANCY SERVICE FOR ELECTRICAL WORK AT AGI M4 (5 FLOORS) HANGER SYSTEM (STITCHING DEPARTMENT)			JOB	1.00		0.00			
2	80000	CONSULTANCY SERVICE FOR REVAMPING/REDESIGNING OF M1 UNIT POWER HOUSE LT PANELS			JOB	1.00		0.00			

Total: PKR

### TERMS & CONDITIONS:

If GST/BIR /Commercial Invoice will be sent after 5<sup>th</sup> of the following month, payment will be delayed

Delivery Required Immediately

All goods must be comply with latest version of Indtex CTW & MRSL

All goods delivery must be in original container & original labels include with product name, manufacturing name and Lot # on it.

PAYMENT: 100% Advance

### REMARKS:

CONSULTANCY SERVICE FOR ELECTRICAL WORK AT AGI M4 (5 FLOORS) HANGER SYSTEM (STITCHING DPT.

)REVAMPING/REDESIGNING OF M1 PH LT PANELS PR#84942/44 -

LC/TT/FDBC/FOC # :

NABEEL ZIA

Prepared by  
Incharge

SCM.RIAZLADHA

Checked By  
Audit/Accounts

Authorized By  
HO/TD/GM

Approved By  
Director

Print By: NABEEL ZIA

Print Date: 7/6/2021 14:22 PM

PDF Name: PO\_PURCHASE\_ORDER

Page 1 of 1

Head Office/ AGI-2, Plot#71,72, Sector 28, KIA, Karachi.Karachi



# Artistic Fabric and Garment Industries (Private) Limited

Manufacturer & Exporter of Denim Fabric & Ready Made Fashion Garments

39/A Block 6 P.E.C.H.S, Shahra-e-Faisal, Karachi-75400 Pakistan

UAN: (92-21)111004004, 34524411, 34524485

GST: 12-02-6200-003-82, NTN: 0709709-3

Pcm/pur/4/009

Issue#02

Date:11-06-2019

## Standard Purchase Order

Supplier Code : 1273 PO Number(0): 419  
Supplier: Advance Engineering Associates Purchase Order Date: 22-MAY-21  
Address: Suite # 313 3rd Floor Anum Estate Department: ADMIN - CONSTRUCTIONS  
Shahrah-e-Faisal Muhammad Aslam  
Shelot Karachi PK  
Phone: PR No 388  
PR Date: 31-MAY-21 PR Approval Date: 01-JUN-21  
Mobile: Project:  
Email: Unit: (ASU) Plot # 33-36 Tappo Landhi, Bin Qasim Town,  
KarachiKarachi  
N.T.N: 0775838-3 Bill To: 39/A, Block 6, P.E.C.H.S, Shahrah-e-FaisalKarachi  
S.T.R.N : PI Number:  
Location: Department(Buyer):  
Unit Name : AGI Spinning Unit Job #  
Status: IN PROCESS 25-MAY-21 Creation Type : Auto Create

S.#	Prefix	Item Description	Detail /	Need by Date	UOM	Qty	Rate (PKR)	DISC	Tax Code	Net Rate (PKR)	Value (PKR)
1	80000	CONSULTANCY CHARGES FOR ELECTRIFICATION WORK OF I.T AND EXTRA LOW VOLTAGE SYSTEM ONLY SPINNING BUILDING			SQF		1.80	0.00		1.80	

Total: PKR

### TERMS & CONDITIONS:

If GST/Bill /Commercial Invoice will be sent after 5<sup>th</sup> of the following month, payment will be delayed

Delivery Required Immediately

All goods must be comply with latest version of inditex CTW & MRSL,

All goods delivery must be in original container & original labels include with product name, manufacturing name and Lot # on it.

### PAYMENT:

### REMARKS:

25%Advance with WorkOrder,25 Conceptual Design Drwaing,25%on submission of BOQ

Tender Document/Quotation Document,25% During the execution of work -

WAQAR.ISHTIAQ

Prepared by  
Incharge

SCM.RIAZLADHA

Authorized By  
HO/TD/GM

Approved By  
Director

Print By: WAQAR.ISHTIAQ

Print Date:6/1/2021 13:47 PM

PDF Name:PO\_PURCHASE\_ORDER

Page 1 of

Head Office/ Plot # 33-36 Tappo Landhi, Bin Qasim Town, KarachiKarachi



# Artistic Fabric and Garment Industries (Private) Limited

Manufacturer & Exporter of Denim Fabric & Ready Made Fashion Garments

39/A Block 6 P.E.C.H.S, Shahra-e-Faisal, Karachi-75400 Pakistan

UAN: (92-21)111004004, 34524411, 34524485

GST: 12-02-6200-003-82, NTN: 0709709-3

Pcm/pur/4/009

Issue#02

Date:11-06-2019

## Standard Purchase Order

Supplier Code : 1273 PO Number(0): 43  
 Supplier: Advance Engineering Associates Purchase Order Date: 15-JUN-21  
 Address: Suite # 313 3rd Floor Anum Estate Department: ADMIN - CONSTRUCTIONS  
 Shahrah-e-Faisal Muhammad Aslam  
 Shelot Karachi PK  
 Phone: PR No: 49  
 PR Date: 15-JUN-21 PR Approval Date: 15-JUN-21  
 Mobile: Project:  
 Email: (Unit: (DM2) Plot Survey # 31-36 Tappo Landhi, Bin Qasim Town,  
 District Malir, KarachiKarachi  
 N.T.N: 0775838-3 Bill To: 39/A, Block 6, P.E.C.H.S, Shahrah-e-FaisalKarachi  
 S.T.R.N : PI Number:  
 Location: Department(Buyer):  
 Unit Name : AGI Denim Mill 2 Job #  
 Status: INCOMPLETE Creation Type : Auto Create

S.#	Prefix	Item Description	Detail /	Need by Date	UOM	Qty	Rate (PKR)	DISC	Tax Code	Net Rate (PKR)	Value (PKR)
1	80000	Consultancy proposal for Electrification work of AGI Denim-02 (Weaving & Utilities) Departments			JOB	1.00		0.00			

Total: PKF

### TERMS & CONDITIONS:

If GST/Bill /Commercial Invoice will be sent after 5<sup>th</sup> of the following month, payment will be delayed

Delivery Required Immediately

All goods must be comply with latest version of inditex CTW & MRSL.

All goods delivery must be in original container & original labels include with product name, manufacturing name and Lot # on it.

PAYMENT: 50%adv,remain pay as per quotation pay schedule.

### REMARKS:

LC/TT/FDBG/FOC # :

WAQAR.ISHTIAQ

Prepared by  
Incharge

Checked By  
Audit/Accounts

Authorized By  
HO/TO/GM

Approved By  
Director

Print By: WAQAR.ISHTIAQ

Print Date:6/22/2021 12:04 PM

RDF Name:PO\_PURCHASE\_ORDER

Page 1 of

Head Office/ Plot Survey # 31-36 Tappo Landhi, Bin Qasim Town, District Malir, KarachiKarachi



# Artistic Fabric and Garment Industries (Private) Limited

Manufacturer & Exporter of Denim Fabric & Ready Made Fashion Garments

39/A Block 6 P.E.C.H.S, Shakra-e-Faisal, Karachi-75400 Pakistan

UAN: (92-21)111004004, 34524411, 34524485

GST: 12-02-6200-003-82, NTN: 0709709-3

Pcm/pur/4/009

Issue#02

Date:11-06-2019

## Standard Purchase Order

Supplier Code : 1273 PO Number(0): 33540  
Supplier: Advance Engineering Associates Purchase Order Date: 10-MAY-21  
Address: Suite # 313 3rd Floor Anum Estate Department: ELECTRICAL  
Shahrah-e-Faisal Muhammad Aslam  
Shelot Karachi PK  
Phone: 021-34311985-6 PR No 13292  
PR Date: 08-MAY-21 PR Approval Date: 08-MAY-21  
Mobile: Project:  
Email: ae.associates@yahoo Unit: (FM2) Plot No. 14, Survey No. 16, 17, Deh Khando, Bin Qasim  
Town, Main National HighwayKarachi  
N.T.N: 0775838-3 Bill To: Plot No. 14, Survey No. 16, 17, Deh Khando, Bin Qasim  
Town, Main National HighwayKarachi  
S.T.R.N : PI Number:  
Location: FM2 Department(Buyer): MAIN STORE  
Unit Name : AGI Denim Mill Job #  
Status: INCOMPLETE Creation Type : Auto Create

S.#	Prefix	Item Description	Detail /	Need by Date	UOM	Qty	Rate (PKR)	DISC	Tax Code	Net Rate (PKR)	Value (PKR)
1	80000	Consultancy & Services Charges	Consultancy Proposal for Revamping of Electrical Drawings at AGI Denim	20-MAY-21	JOB	1.00		0.00	INPUT SRB @ 13%		

Total: PKR

### TERMS & CONDITIONS:

If GST/Bill /Commercial Invoice will be sent after 5<sup>th</sup> of the following month, payment will be delayed

Delivery Required Immediately

All goods must be comply with latest version of inditex CTW & MRSL.

All goods delivery must be in original container & original labels include with product name, manufacturing name and Lot # on it.

PAYMENT: 100% Advance

### REMARKS:

M.SHEHROZ

Prepared by  
Incharge

Checked By  
Audit/Accounts

Authorized By  
HO/TD/GM

Approved By  
Director

Print By: M.SHEHROZ

Print Date:5/10/2021 15:55 PM

RDF Name:PO\_PURCHASE\_ORDER

Page 1 of

AGI Denim Mill/ Plot No. 14, Survey No. 16, 17, Deh Khando, Bin Qasim Town, Main National HighwayKarachi

**SOORTY ENTERPRISES (PRIVATE) LIMITED**  
**WORK ORDER**



Date : 16-Feb-2022

Order No SER2200055

Organization: 08

**Detail of Work to be Outsourced**

<b>Job Detail:</b> Consultancy Proposal for Electrical Work of 120 Looms (Phase-I), Chemical Store, Rope Dyeing								
<b>Coordinating Person's:</b> Mr. Alam Mazheri								
<b>Designation:</b> COO Denim								
<b>Contractor Name:</b> ADVANCE ENGINEERING ASSOCIATES (0775838-3)								
<b>Status :</b> N/A								
<b>Expected Start Date</b>	<b>Expected date of completion</b>	<b>Actual date of Completion</b>	<b>Material Provided by</b>					
16-Feb-2022	16-Feb-2022							
<b>Mode of Payment:</b> Cheque	<b>Withholding Tax:</b> Yes	<b>Payment Terms:</b> ADVANCE PAYMENT						
<b>SERVICE / LABOUR</b>								
<b>Description</b>	<b>DEPARTMENT</b>	<b>UOM</b>	<b>Quantity</b>	<b>Curr.</b>	<b>Price</b>	<b>S.Tax</b>	<b>S.T Amt</b>	<b>Amount</b>
CIP - CAPITAL WORK IN PROCESS	WEAVING PRODUCTION 3 - Denim Unit	num	1.00	PKR				
<b>Total Amount</b>								
<b>MATERIAL</b>								
<b>Description</b>	<b>UOM</b>	<b>Quantity</b>	<b>Curr.</b>	<b>Price</b>	<b>S.Tax %</b>	<b>S.T Amount</b>	<b>Amount</b>	
<b>Total Amount</b>								
<b>Estimated Cost of the Job</b>	<b>Material</b>	<b>Labour</b>	<b>Discount</b>	<b>Total</b>				

**Remarks** Consultancy Proposal for Electrical Work of 120 Looms (Phase-I), Chemical Store, Rope Dyeing :

- Payment Term:**
- 25% Advance
  - 25% on Submission of Conceptual Drawings
  - 25% Preparation of Tender/ Quiltation Documents
  - 25% during execution of work

pur04-u08

Prepared by

Coordinating Person

Approved by



# CRAFTERS POLYPROPYLENE PACKAGES (PVT) LIMITED

REF:CPPPL/2021/01

Karachi, dated, December 18, 2021.

Mr. Rakhshan Ali Khan  
Chief Executive  
Advance Engineering Associates  
Suite # 313, 3<sup>rd</sup> Floor, Anum Estate,  
Shahra-e-Faisal  
Karachi  
Phone: 021-34311985, Mobile: 0345-2006613

**SUB: WORK ORDER FOR PROVIDING FULL CONSULTANCY, DESIGN DRAWINGS, CALCULATION SHEETS, BOQ, BUDGETARY ESTIMATES, SUPERVISION ETC. RELATING TO ALL ELECTRICAL WORKS AT NEW PROJECT CRAFTERS POLYPROPYLENE PACKAGES (PVT) LTD. SITUATED AT PLOT BEARING NO. LE-70-A01, BIN QASIM INDUSTRIAL PARK-SPECIAL ECONOMIC ZONE, NEAR STEEL MILL, KARACHI.**

Dear Sir,

With reference to your proposal referenced AEA/A/0047#8154 dated 29.10.2021 and our subsequent meetings and as agreed by you, we are pleased to award you the work order for providing Full Consultancy for the completion all electrical works at our new project, Crafters Polypropylene Packages (Pvt) Ltd., BQIP-SEZ, Karachi with complete Project Designing, Planning, and all Related Services, Support and Supervision during Execution covering unlimited visits etc. up to the commissioning and start up of the factory and as specified at a total lump sum (fixed) Consultancy Fees / Charges of Rs. (Rupees ) which will be inclusive of all applicable/prevaling government taxes, with-holding/advance tax & charges.

As agreed, the above lump sum fees/charges shall cover all factory area, Substation, D.G Set etc. and will be inclusive of all works elaborated in the different parts of the 'Scope of Services' of your said letter referred to above viz. Conceptual Design, Internal Electrification, External Electrical Works, Preparation of Tender / Quotation Documents, Issue of Documents to Contractors, Supervision, which will also form integral part of this Work Order.

Other terms and conditions of this Work Order shall be as follows:

1. You will prepare and submit to us a. Conceptual /Schematic /Detailed Design Drawings of Electrical Works, b. Calculation Sheets, c. BOQ, d. Budgetary Estimates as soon as possible.

## **Shabbir Tiles & Ceramics Limited**

15th Mile Stone, National Highway, Landhi, Karachi-75120

Phone No. 5015024-25, Fax No. 5015545

S.Tax Reg. # 02-04-6907-001-37

### **ADVANCE ENGINEERING ASSOCIATES**

BillTo .

Phone :

Your Ref No. :

Ref No. : 2910257

Order Date : 23.12.2021

Delivery Date : 23.12.2021

### **Job Order - Unit 2**

Kindly arrange to Supply/Manufacture/Process the Goods/Items as per term and condition mentioned here.

#	Description	Quantity	Rate	Sales Tax	Total Payment Due
1	CONSULTANCY (4-5) MW K-ELEC POWER FOR LOAD ENHANCEMENT,UP-GRADATION & MODIFIC OF EXISTING POWER.	1	0	11	PKR

Total ==> \_\_\_\_\_

Total Rupees ==> \_\_\_\_\_

25% advance 25% on submission conceptual drawing 25% on tender docs, 25% during execution work.

The Service/job/ process strictly according with our required specification/sample.

We would not be responsible for any payment,if the services rejected.

Thank you for your co-operation

**for SHABBIR TILES & CERAMICS LTD**

Created on: 23.12.2021

\_\_\_\_\_  
**DEPARTMENT'S MANAGER**

## **Shabbir Tiles & Ceramics Limited**

15th Mile Stone, National Highway, Landhi, Karachi-75120

Phone No. 5015024-25, Fax No. 5015545

S.Tax Reg. # 02-04-6907-001-37

### **ADVANCE ENGINEERING ASSOCIATES**

BillTo .

Phone :

Your Ref No. :

Ref No. : 2910256

Order Date : 23.12.2021

Delivery Date : 23.12.2021

### **Job Order - Unit 1**

Kindly arrange to Supply/Manufacture/Process the Goods/Items as per term and condition mentioned here.

#	Description	Quantity	Rate	Sales Tax	Total Payment Due
1	CONSULTANCY (1-2.7) MW K-ELEC POWER FOR LOAD ENHANCEMENT,UP-GRADATION & MODIFIC OF EXISTING POWER.	1		11	PKR

Total ==>

Total Rupees ==>

25% advance 25% on submission conceptual drawing 25% on tender docs, 25% during execution work.

The Service/job/ process strictly according with our required specification/sample.

We would not be responsible for any payment,if the services rejected.

Thank you for your co-operation

for SHABBIR TILES & CERAMICS LTD

Created on: 23.12.2021

DEPARTMENT'S MANAGER

**Work Order**

WO Number:	Z047
WO Date:	22-11-2021
Supplier ID:	500936
Supplier Name:	ADVANCE ENGINEERING ASSOCIATES.
Supplier Address:	Karachi
Remarks:	
Department:	PRODUCTION-POWER HOUSE

Payment Mode:	Cheque
Payment Terms:	25% as Advance with work order 25% on Submission of Conceptual drawings 40% during the execution of work 10% after completion
Project Title	

Delivery Place:	Sukkur Beverages A-10, S.I.T.E. Sukkur
Delivery Method:	Installation by Vendor
Delivery Date:	
Delivery Terms:	
Currency:	PKR

Description	Item	Details	Unit	Qty	Rate	Gross Amount	Sales Tax		Freight	Net Amount
							Rate	Amount		
General Services		Scope of work: 1. Detail As-Built drawing with SLD. 2. Insulation test (Max 25 Nos. Ckt). 3. Earth test substation/Power House. 4. Harmonic test (02 Nos.) 5. Thermography test (included).	SET	1			0.00	0.00		
<b>Grand Total:</b>									0.00	

**Approvals:**

Initiator	SYED FARHAN ALL [ POWER HOUSE ] Nov 22, 2021 10:13 AM
HOD Approval	MOHSIN AHMED [ POWER HOUSE ] Nov 22, 2021 10:14 AM
Procurement	USMAN AHMED MALIK [ PROCUREMENT ] Nov 22, 2021 6:02 PM
Audit Approval	TAHIR ZIA AWAN [ AUDIT ] Nov 26, 2021 2:38 PM
Final Approval	MUHAMMAD ARSHAD [ OPERATIONS ] Nov 27, 2021 1:43 AM



Our Ref: FAP/WO/NOV17/01/2021

Dated: 17<sup>th</sup> Nov, 2021

To: **M/s. Advance Engineering Associate**

**Subject: Work Order – Design & Consultancy Work of New Unloaders & Terminal Load Enhancement.**

Dear Sir,

Reference to your quotation No. AEA/D/0047#8119 Dated 12<sup>th</sup> Nov, 2021 regarding Design & Consultancy Services of Electrical Works for 2 Nos. Bulk Unloader and Load Enhancement from 1.25 MW to 3.15 MW in Existing Distribution System at M/s. FAP Marine Terminals in Port Qasim, Karachi.

We are pleased to confirm you work order for the subjected job as follow:

**A- SCOPE OF WORK**

- **Study & Examination of Existing Power Distribution System with Conceptual Plan**
  - a) Study and examine the existing distribution scheme, HT Panels and detail provided by FAP and define electrical works to be carried out to satisfy the system requirement.
  - b) Inspection of existing Electrical Network with single line diagram (Electrical Distribution Panels & Feeders) for hook up the new load.
  - c) Compute total electrical load requirement inclusive of existing, new & provision of future expansion, and advice means and method of availability of the same.
  - d) Prepare conceptual SLD (Single Line Diagram) with load enhancement up to 3.2 MW.
  - e) Study and examine upgradation of Power Factor Improvement Plant.
  - f) Study & examine the load requirement of 02 Nos. of Bulk unloaders.
  - g) Study of existing cable draw pits & Fresh water lines & define the works to be carried out for construction of K-Electric Sub Station.
  - h) Study for upgradation of existing step-down transformer in accordance with new load.
- **Based on finally agreed conceptual design, Prepare final design for the project**

**Covering:**

  - a) Propose SLD with Load Enhancement / Up-gradation of H.T Panels with bus bar & C.Ts ratio.
  - b) Propose Civil layout of Substations for new distribution system.

Fauji Akbar Portfile Marine  
Terminals Ltd  
Port Bin Qasim  
Karachi-75020, Pakistan  
Tel: (92-21) 34730080-81  
Fax: (92-21) 34730084  
info@fapterminals.com  
fapterminals.com



- c) Powerhouse up-gradation with new Emergency Generator Set to cater additional Load requirement.
- d) Designing, sizing and proper selection of VCB, Breaker, Main & Sub Main Cables, and its routing with Voltage drop.
- e) Conduct Short Circuit Analysis to satisfy the system requirement.
- f) Study & examine Earthing System
- g) Load Flow analysis & short circuit study on ETAP Latest version Software.

• **Final Design and Construction Documents**

- a) Based on finally agreed design, prepare final drawing (on Auto-CAD format) coordinate with other services and details good for execution.
- b) Prepare construction documents with conditions of contract, schedule of quantities and technical specifications for materials and workmanship.
- c) Invite bids from contractors, suppliers and manufactures for the execution of works.
- d) Scrutinize quotations and recommend for selection of suitable contractors, suppliers, and manufacturers.

• **11 KV Synchronization (PQA & K-ELECTRIC)**

- a) Prepare design drawings for Synchronization of PQA & K-Electric Supply. (IF K-Electric
- b) Allow to synch its system)
- c) Priority selection of both supplies.
- d) Failover if any one of the supplies got shut-off.
- e) If load increase from 2 MW over K-Electric than Additional load requirement to be shifted automatically/manual to PQA.

**B- TOP SUPERVISION**

Top supervision & Bill verification for the electrical works through Site visits (maximum 6 Nos) During execution of job and guard the owner against defects and deficiencies in the works of contractors, suppliers and manufacturers.

**C- PROJECT COMPLETION TIME (DESIGN WORK ONLY):**

2 to 3 Weeks.

**D- CONSULTANCY COST**

Total Cost of Design and Consultancy work is PKR

/- (Inclusive of tax)

Fauji Akbar Portia Marine  
Terminals Ltd  
Port Bin Qasim  
Karachi-75020, Pakistan  
Tel: (92-21) 34730080-81  
Fax: (92-21) 34730084  
Info@fapterminals.com  
fapterminals.com



**E- PAYMENT TIMELINE**

Payments shall be release to the consultant on below given timeline:

- a) 25% as Advance with Work Order.
- b) 25% on submission of conceptual design.
- c) 25% on submission of final design with Tender / Quotation Documents.
- d) 25% after the execution of works.

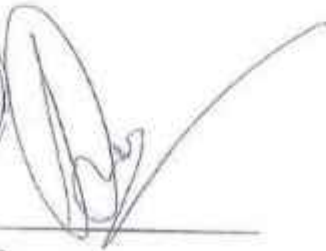

**Shakeel Khan**  
**Senior Manager Technical Services**

Control No: ERP-004-WO/GD

Date: 01-JUN-2021

Work Order No: 69185

Organization Name: SEL 08 OU

**Detail of Work to be Outsourced**

Job Detail: **Consultancy Services for 4-5 MW K-Electric Power for System Upgradation and 3 MW Sub-Station for Garment Unit**

Coordinating Person's: Mr. Alam Mazhari

Designation: COO Denim

Contractor Name: **ADVANCE ENGINEERING ASSOCIATES**

NTN Number: 0775838-3

Supplier Address: **SUITE NO 313 3RD FLOOR ANUM ESTATE SHAHRAH-E-FAISAL, KARACHI**

Expected Start Date	Expected date of completion	Actual date of Completion	Material Provided by
2021/06/01	2021/06/01		Company
Mode of Payment: <b>Cheque</b>	Withholding Tax: <b>Yes</b>	Payment Terms: <b>Advance Payment</b>	

**SERVICE / LABOUR**

Description / Task	Narration	Department	FA#	Charge Acc. Description	Qty	Curr.	Unit Price	Sales Tax %	ST Amount	Amount
CIP - CAPITAL IN PROCESS		ELECTRICAL COMMON - Denim Unit		NONE CIP CLEARING	1	PKR		13.00		
<b>Total Amount</b>										

**MATERIAL**

Item Code	Description	FA #	Quantity	Unit Price	currency	S Tax%	S Tax	Amount
<b>Total Amount</b>								

Estimated Cost of the Job	Material	Labour	Discount	Adv Tax %	Tax Amount	Total
			0	0	0	

Remarks:

Quote Ref: AEA/B/047#8006

Consultancy Services for 4-5 MW K-Electric Power for System Upgradation and 3 MW Sub-Station for Garment Unit : 800,000/-

Payment Term:

30% Advance with PO

30% on Submission of Conceptual Drawings,

30% on preparation of tender/ Quotation documents

30% during execution of work

101219-08

Prepared by

Coordinating Person

Approved by

# Artistic Fabric and Garment Industries (Private) Limited

Manufacturer & Exporter of Denim Fabric & Ready Made Fashion Garments

39/A Block 6 P.E.C.H.S, Shahra-e-Faisal, Karachi-75400 Pakistan

UAN: (92-21)111004004, 34524411, 34524485

GST: 12-02-6200-003-82, NTN: 0709709-3

PCM/PUR/4/009

Issue#02

Date:11-06-2019

## Standard Purchase Order

Supplier Code : 1273 PO Number(0): 183724  
Supplier: Advance Engineering Associates Purchase Order Date: 29-OCT-21  
Address: Suite # 313 3rd Floor Anum Estate Department: ELECTRICAL  
Shahrah-e-Faisal Muhammad Aslam  
Shelof Karachi PK  
Phone: 021-34311985-6 PR No 89713  
PR Date: 27-OCT-21 PR Approval Date: 27-OCT-21  
Mobile: Project:  
Email: ae.associates@yahoo Unit: (K2) AGI-2, Plot#71,72, Sector 28, KIA, Karachi.Karachi  
N.T.N: 0775838-3 Bill To: AGI-2, Plot#71,72, Sector 28, KIA, Karachi.Karachi  
S.T.R.N : PI Number:  
Location: AGI - K2 Department(Buyer): Purchase  
Unit Name : Garment Division - K2 Job #  
Status: IN PROCESS Creation Type : Auto Create

S.#	Prefix	Item Description	Detail /	Need by Date	UOM	Qty	Rate (PKR)	DISC	Tax Code	Net Rate (PKR)	Value (PKR)
1	80000	CONSULTANCY PROPOSAL FOR SHIFTING OF POWER HOUSE EQUIPMENT TO NEW LOCATION AT AGI UNIT K-13			JOB	1.00		0.00			

Total: PKF

Note: Invoice will must be submit to Accounts Dept in Seven days after complete the delivery.

### TERMS & CONDITIONS:

If GST/Bill /Commercial Invoice will be sent after 5<sup>th</sup> of the following month, payment will be delayed

Delivery Required Immediately

All goods must be comply with latest version of inditex CTW & MRSL.

All goods delivery must be in original container & original labels include with product name, manufacturing name and Lot # on it.

PAYMENT: 50%adv,remain pay as per quotation pay schedule.

### REMARKS:

Required for consultancy proposal for shifting of power house equipment to new location at Agi k-13 89713 -

LC/TT#FDBC/FOC # :

ZEESHAN KHAN

Prepared by  
Incharge

SCM.RIAZLADHA

Checked By  
Audit/Accounts

Authorized By  
HO/TD/GM

Approved By  
Director

Print By: NABEEL.ZIA

Print Date:10/29/2021 13:12 PM

RDF Name:PO\_PURCHASE\_ORDER

Page 1 of

Garment Division - K2/ AGI-2, Plot#71,72, Sector 28, KIA, Karachi.Karachi



# CONTINENTAL BISCUITS LTD.

Floor # 12, Q.M. Building, Plot # BC-15, Block-7, KDA  
Scheme # 5, Clifton, Karachi.  
Phones: 9221-111-771-771, Fax9221-35147110



## PURCHASE ORDER

<b>Supplier M/s</b> ADVANCE ENGINEERING ASSOCIATES Suite # 313,3rd Floor, Anum Estate, Shahrah-e-faisal Karachi Karachi - P.O.Box:	<b>Purchase Order No</b> : 4500040128 <b>Purchase Order Date</b> : 28.07.2021 <b>Supplier Ref. Docs. No</b> <b>Payment Terms</b> : <b>GST# 01-02-1905-002-73 NTN # 0710106-6</b>
<b>Supplier NTN / CNIC:</b> 0775838-3 / 4220108580349 <b>Delivery Address :</b> B-62, S.I.T.E. SHIKARPUR ROAD, SUKKUR	
Please arrange to supply the following:	

Stock Code	Item Description	Unit	Price Per Unit	Quantity	Sales Tax	Value Excl. S.Tax	Delivery Date
	THERMOGRAPHY ELEC POWR DIST SYS 20 POINT	AU		1			
<b>GRAND TOTAL</b>							

### Transporter Charges

<b>Remarks :</b>	<b>Total Value Exclusive Taxes in PKR</b> : <b>Sales Tax Amount</b> : <b>Other Charges / Non-Claimable SED : 0.00</b> <b>Total Purchase Order Value in PKR</b> :
------------------	---

 <i>Signature</i>	 <i>Signature</i>	 <i>Finance Approval</i>	<i>Director's Approval</i>
---	---	---	----------------------------

<b>Terms &amp; Conditions :</b>
<ol style="list-style-type: none"> <li>All items must be supplied as per specification &amp; subject to approval of our quality control department at Sukkur Factory / Head Office.</li> <li>Upon receipt item must have a minimum one year shelf life.</li> <li>All invoices must be mailed or directly delivered to the Accounts department.</li> <li>PO number must appear on all delivery items, invoices and correspondence.</li> </ol>



Control No: ERP-004-WO/GD

Date: 01-JUN-2021

Work Order No: 69185

Organization Name: SEL 08 OU

**Detail of Work to be Outsourced**

Job Detail: **Consultancy Services for 4-5 MW K-Electric Power for System Upgradation and 3 MW Sub-Station for Garment Unit**

Coordinating Person's: Mr. Alam Mazhari

Designation: COO Denim

Contractor Name: **ADVANCE ENGINEERING ASSOCIATES**

NTN Number: 0775838-3

Supplier Address: **SUITE NO 313 3RD FLOOR ANUM ESTATE SHAHRAH-E-FAISAL, KARACHI**

Expected Start Date	Expected date of completion	Actual date of Completion	Material Provided by
2021/06/01	2021/06/01		Company
Mode of Payment: <b>Cheque</b>	Withholding Tax: <b>Yes</b>	Payment Terms: <b>Advance Payment</b>	

**SERVICE / LABOUR**

Description / Task	Narrtion	Department	FA#	Charge Acc. Description	Qty	Curr.	Unit Price	Sales Tax %	ST Amount	Amount
CIP - CAPITAL IN PROCESS		ELECTRICAL COMMON - Denim Unit		NONE CIP CLEARING	1	PKR		13.00		

**Total Amount**

**MATERIAL**

Item Code	Description	FA #	Quantity	Unit Price	currency	S Tax%	S Tax	Amount
<b>Total Amount</b>								

Estimated Cost of the Job	Material	Labour	Discount	Adv Tax %	Tax Amount	Total
			0	0	0	

Remarks:

Quote Ref: AEA/B/047#8006

Consultancy Services for 4-5 MW K-Electric Power for System Upgradation and 3 MW Sub-Station for Garment Unit :

Payment Term:

10% Advance with PO

10% on Submission of Conceptual Drawings.

10% on preparation of tender/ Quotation documents

10% during execution of work

101219-08

Prepared by

Coordinating Person

Approved by

## Work Order

WO Number:	2014
WO Date:	30-10-2021
Supplier ID:	500936
Supplier Name:	ADVANCE ENGINEERING ASSOCIATES
Supplier Address:	Karachi
Remarks:	
Department:	PRODUCTION-POWER HOUSE

Payment Mode:	Cheque
Payment Terms:	25% as Advance with work order 25% on Submission of Conceptual drawings 40% during the execution of work 10% after completion

Delivery Place:	Sukkur Beverages A-10, S.I.T.E. Sukkur
Delivery Method:	Installation by Vendor
Delivery Date:	
Delivery Terms:	
Currency:	PKR

Description	Item Details		Qnty	Rate	Gross Amount	Sales Tax		Freight	Net Amount
	Unit	Details				Rate	Amount		
General Services	NOS	electrical consultancy services as per the attached agreement inclusive of (W.H.T).	1			0.00	0.00		
<b>Grand Total:</b>									0.00

### Approvals:

Initiator	SYED FARHAN ALI [ POWER HOUSE ] Oct 30, 2021 12:46 PM
HoD Approval	MOHSIN AHMED [ POWER HOUSE ] Oct 30, 2021 12:47 PM
Procurement	USMAN AHMED MALIK [ PROCUREMENT ] Nov 1, 2021 5:11 PM
Audit Approval	TAHIR ZIA AWAN [ AUDIT ] Nov 2, 2021 5:08 PM
Final Approval	MUHAMMAD ARSHAD [ OPERATIONS ] Nov 2, 2021 6:29 PM

# Artistic Denim Mills Limited

ADM-STR-031

Plot No. 5-9,23-26 Sector 16,  
Korangi Industrial Area  
Karachi Sindh, Pakistan.

**Phone:** +92-111-236-236

**Fax:** +92-21-35054652

**NTN:** 0704132-2

**GST No:** 12-02-5209-003-91

**Email:** email@admdenim.com

## WORK ORDER

The following number must appear on all related correspondence, shipping papers, and invoices.

**W.O. Number:** WO-00076232

**W.O. Date:** 29-Apr-2021

**Requested By:** Garments

### TO:

**Name:** Advance Engineering Associates

**Address:** Suit # 313, 3rd Floor, Anum Estate Shakra-e-Faisal, Karachi Sindh Pakistan.

**Phone:** 021-34311985-6

**Fax:**

**NTN:** 0775838-3

**GST No:**

**Email:** Ae.associates@yahoo.com

**CNIC:** -

### SHIP TO:

**Company:** Artistic Denim Mills Limited

**Address:** Plot No. 5-9,23-26 Sector 16, Korangi Industrial Area Karachi Sindh, Pakistan.

**Phone:** +92-111-236-236

**Email:** electrical@admdenim.com

Delivery Date	Terms Of Payment	Orderer	Mode of Delivery	Service Terms
29-Apr-2021	50% Adv.	Rizwan Arshad	House Job	Urgent

S.No.	Item ID	Description	Department	Style	Color	Size	Quantity	Unit	Unit Price (PKR)	Total (PKR)
1	S00075516 CWIP. Serv	Consultancy Service Of Lightning Protection System	ADM-3 (New building)				1.00	job		

### Terms and Conditions

1. Enter this order in accordance with the prices, terms, service method and specifications listed above.
2. Please notify us immediately if you are unable to service as specified.

Send all correspondence to:  
Artistic Denim Mills Limited

DISCOUNT 0%	0.00
AFTER DISCOUNT	
SALES TAX	0.00
FREIGHT	0.00
OTHER	0.00
TOTAL PKR	

# Artistic Denim Mills Limited

ADM-STR-031

Plot No. 5-9,23-26 Sector 16,  
Korangi Industrial Area  
Karachi Sindh, Pakistan.

Phone: +92-111-236-236

Fax: +92-21-35054652

NTN: 0704132-2

GST No: 12-02-5209-003-91

Email: email@admdenim.com

## WORK ORDER

The following number must appear on all related correspondence, shipping papers, and invoices.

W.O. Number: **WO-00075143**

W.O. Date: 08-Apr-2021

Requested By: Garments

### TO:

Name: **Advance Engineering Associates**

Address: Suit # 313, 3rd Floor, Anum Estate Shakra-e-Faisal, Karachi Sindh Pakistan.

Phone: 021-34311985-6

Fax:

NTN: 0775838-3

GST No:

Email: Ae.associates@yahoo.com

CNIC:

### SHIP TO:

Company: Artistic Denim Mills Limited

Address: Plot No. 5-9,23-26 Sector 16, Korangi Industrial Area Karachi Sindh, Pakistan.

Phone: +92-111-236-236

Email: electrical@admdenim.com

Delivery Date	Terms Of Payment	Orderer	Mode of Delivery	Service Terms
08-Apr-2021	50% Adv.	Rizwan Arshad	House Job	Urgent

S.No.	Item ID	Description	Department	Style	Color	Size	Quantity	Unit	Unit Price (PKR)	Total (PKR)
1.	S00074955 Rep&M-L&B	Consultancy Proposal For Single Point Harmonic Testing	Laser-G2				1.00	job		

### Terms and Conditions

1. Enter this order in accordance with the prices, terms, service method and specifications listed above.
2. Please notify us immediately if you are unable to service as specified.

Send all correspondence to:  
Artistic Denim Mills Limited

DISCOUNT 0%	0.00
AFTER DISCOUNT	
SALES TAX	0.00
FREIGHT	0.00
OTHER	0.00
TOTAL PKR	

# Artistic Denim Mills Limited

ADM-STU-031

Plot No. 5-9,23-26 Sector 16,  
Korangi Industrial Area  
Karachi Sindh, Pakistan.

Phone: +92-111-236-236

Fax: +92-21-35054652

NTN: 0704132-2

GST No: 12-02-5209-003-91

Email: email@admdenim.com

## WORK ORDER

The following number must appear on all related correspondence, shipping papers, and invoices.

W.O. Number: WO-00074364

W.O. Date: 24-Mar-2021

Requested By: Garments

### TO:

Name: Advance Engineering Associates

Address: Suit # 313, 3rd Floor, Anum Estate Shakra-e-Faisal, Karachi Sindh Pakistan.

Phone: 021-34311985-6

Fax:

NTN: 0775838-3

GST No:

Email: Ae.associates@yahoo.com

CNIC:

### SHIP TO:

Company: Artistic Denim Mills Limited

Address: Plot No. 5-9,23-26 Sector 16, Korangi Industrial Area Karachi Sindh, Pakistan.

Phone: +92-111-236-236

Email: electrical@admdenim.com

Delivery Date	Terms Of Payment	Orderer	Mode of Delivery	Service Terms
24-Mar-2021	50% Adv	Rizwan Arshad	House Job	Urgent

S.No.	Item ID	Description	Department	Style	Color	Size	Quantity	Unit	Unit Price (PKR)	Total (PKR)
1	S00074603 CWIP. Serv	Consultancy Proposal Electrical Thermographic Inspection	ADM-3 (New building)				1.00	job		

### Terms and Conditions

1. Enter this order in accordance with the prices, terms, service method and specifications listed above.
2. Please notify us immediately if you are unable to service as specified.

Send all correspondence to:  
Artistic Denim Mills Limited

DISCOUNT 0%	0.00
AFTER DISCOUNT	
SALES TAX	0.00
FREIGHT	0.00
OTHER	0.00
TOTAL PKR	

**WORK ORDER**

**Section: A** (To be filled in by the person making request)

FROM:- Mr. Azher Baig DEPARTMENT:- Corn Starch Division

To:- Mr. Rakshan Ali Khan DEPARTMENT:- \_\_\_\_\_

JOB DESCRIPTION:- Consultancy Project for Electrical Distribution System of Corn Starch Project.

Advance Paid

SIGNATURE :- \_\_\_\_\_ DATE:- March 18-2021

**Section: B** (To be filled in by the person assigned)

TYPE OF WORK:

INSTALLATION  MAINTENANCE  SERVICE  OTHERS

NATURE OF WORK

IN HOUSE  OUT SOURCING

INHOUSE:-

ASSIGNED TO:- \_\_\_\_\_ DEPARTMENT: \_\_\_\_\_

DATE: \_\_\_\_\_

OUT SOURCE :-

VENDER NAME: Advance Engineering Associates CONTACT NO: 021-34311985

ADDRESS:- Suit #. 313 3rd Floor Anum Estate Shahr-e-Faisal Karachi -

APPROVED BY:- Mr. Azher Baig SIGNATURE:- *Azher Baig*

DATE:- March 18-2021

**Section: C** (To be filled in by the person making request)

JOB COMPLETION REPORT:- \_\_\_\_\_

VERIFIED BY:- \_\_\_\_\_ SIGNATURE: \_\_\_\_\_

JOB COMPLETION DATE: \_\_\_\_\_



# Artistic Fabric and Garment Industries (Private) Limited

Manufacturer & Exporter of Denim Fabric & Ready Made Fashion Garments

39/A Block 6 P.E.C.H.S, Shahr-e-Faisal, Karachi-75400 Pakistan

UAN: (92-21)111004004, 34524411, 34524485

GST: 12-02-6200-003-82, NTN: 0709709-3

Pcm/pur/4/009

Issue#02

Date:11-06-2019

## Standard Purchase Order

Supplier Code: 1273 PO Number(0): 293  
Supplier: Advanca Engineering Associates Purchase Order Date: 17-MAR-21  
Address: Suite # 313 3rd Floor Anum Estate Department: ADMIN - CONSTRUCTIONS  
Shahr-e-Faisal Muhammad Aslam  
Shelot Karachi PK  
Phone: PR No 270  
PR Date: 16-MAR-21 PR Approval Date: 16-MAR-21  
Mobile: Project:  
Email: Unit: (ASU) Plot # 33-36 Tappo Landhi, Bin Qasim Town,  
KarachiKarachi  
N.T.N: 0775838-3 Bill To: Plot # 33-36 Tappo Landhi, Bin Qasim Town,  
KarachiKarachi  
S.T.R.N : PI Number:  
Location: Department(Buyer):  
Unit Name : AGI Spinning Unit Job #  
Status: IN PROCESS Creation Type : Auto Create

S.#	Prefix	Item Description	Detail /	Need by Date	UOM	Qty	Rate (PKR)	DISC	Tax Code	Net Rate (PKR)	Value (PKR)
1	80000	CONSULTANCY CHARGES FOR ELECTRICAL POWER IMPORT AND EXPORT			JOB	1.00	0	0.00	INPUT SRB @ 10%	0	

Total: PKR

### TERMS & CONDITIONS:

If GST/Bill /Commercial Invoice will be sent after 5<sup>th</sup> of the following month, payment will be delayed

Delivery Required Immediately

All goods must be comply with latest version of inditex CTW & MRSL.

All goods delivery must be in original container & original labels include with product name, manufacturing name and Lot # on it.

PAYMENT: 25 ADV 25 SUB DRAW 25 Prep Tend/Q 25 Dur EXCU OF W

### REMARKS:

WAQAR.ISHTIAQ

Prepared by  
Incharge

Checked By  
Audit/Accounts

Authorized By  
HO/TD/GM

Approved By  
Director

Print By: WAQAR.ISHTIAQ

Print Date:3/17/2021 16:16 PM

RDF Name:PO\_PURCHASE\_ORDER

Page 1 of

AGI Spinning Unit/ Plot # 33-36 Tappo Landhi, Bin Qasim Town, KarachiKarachi



# WORK ORDER

Document Number	DAL-AEA-210216
Document Version	01
Effective Date	25-Feb-21



Attn:

Advance Engineering Associates  
Suite # 313, 3rd Floor, Anam Estate,  
Shahrah-e-Faisal Karachi Pakistan.  
Phone No:00-92-21-34311985-6

WORK ORDER NO.	DATE
DAL-AEA-210222	22-Feb-21

This WORK ORDER NO. and date must be quoted in all correspondence.

1. This order is subject to the terms and conditions set out on the face and the Agreement Number: 010221/CKD/MEP-01/AEA/001 dated: Feb-18-2021

Attn : Mr. Rakhshan Ali Khan (CEO)

Please execute the work described below according to the terms and conditions described herein and in the signed agreement"

### Description of work :

FOR DETAILED DESIGN AND DRAWINGS, CONCEPTUAL DESIGN AND DRAWINGS, TOP SUPERVISION AND WARRANTY OF COMPLETE ELECTRIFICATION WORK, SANITATION & PLUMBING WORK AND MEP WORK OF DYSIN AUTOMOBILE LIMITED AT PLOT # 35, BLOCK M, LIEDA, HUB BALUCHISTAN.

### Work Schedule :

Completion Period : 6 weeks Starting Date: 22-Feb-21 Completion Date: 05-Apr-21

S.No.	Description	Amount (Rs.)
1	Mechanical (ACMV) Services	
2	Electrical system with Load Calculations	
3	Power Layout for departments including Welding area, Paint area, Assembling, Cabin Trim, Drilling, Compressor & Etc (As per Layout)	
4	Communication and other Low Voltage System	
5	Earthing & Lightning Protection System	
6	External Electrical Works	
7	Sanitary & Plumbing Services	
8	Fire Protection Services	
9	Air Compressor System	
10	And any other work required under as per the signed agreement	
Total Amount - Lump Sum ( Inclusive of All Taxes)		

### Payment Terms:

- 25% Advance to with the work order.
- 20% Upon Conceptual Design Drawing / Detailed Design Drawing.
- 25% On submission of BOQ Tendar Documents / Quotation Documents.
- 20% During the execution of work.
- 10% After completion of the project

We agree to execute the above work according to the terms & conditions specified above and in the Signed Agreement (Attached)



03/03/2021  
Date

Consultant signature

For Dysin Automobiles Limited



Hakim Ali  
Name

Chief Operating Officer  
Position



# Artistic Fabric and Garment Industries (Private) Limited

Manufacturer & Exporter of Denim Fabric & Ready Made Fashion Garments

39/A Block 6 P.E.C.H.S, Shakra-e-Faisal, Karachi-75400 Pakistan

UAN: (92-21)111004004, 34524411, 34524485

GST: 12-02-6200-003-82, NTN: 0709709-3

Pcm/pur/4/009

Issue#02

Date:11-06-2019

## Standard Purchase Order

Supplier Code : 1273 PO Number(0): 4  
 Supplier: Advance Engineering Associates Purchase Order Date: 19-FEB-21  
 Address: Suite # 313 3rd Floor Anum Estate Department: ADMIN - CONSTRUCTIONS  
 Shakrah-e-Faisal Muhammad Aslam  
 Shelot Karachi PK  
 Phone: PR No 5  
 PR Date: 18-FEB-21 PR Approval Date: 18-FEB-21  
 Mobile: Project: CWIP-0018  
 Email: Unit: (DM2) Plot Survey # 31-36 Tappo Landhi, Bin Qasim Town,  
 District Malir, KarachiKarachi  
 N.T.N: 0775838-3 Bill To: 39/A, Block 6, P.E.C.H.S, Shakrah-e-FaisalKarachi  
 S.T.R.N : PI Number:  
 Location: Department(Buyer):  
 Unit Name : AGI Denim Mill 2 Job #  
 Status: REQUIRES REAPPROVAL 19-FEB-21 Creation Type : Auto Create

S.#	Prefix	Item Description	Detail /	Need by Date	UOM	Qty	Rate (PKR)	DISC	Tax Code	Net Rate (PKR)	Value (PKR)
1	00000	Service and Labour charges			JOB	1.00	0		INPUT SRB @ 10%	0	

Total: PKI

### TERMS & CONDITIONS:

If GST/Bill /Commercial Invoice will be sent after 5<sup>th</sup> of the following month, payment will be delayed

Delivery Required Immediately

All goods must be comply with latest version of inditex CTW & MRSL.

All goods delivery must be in original container & original labels include with product name, manufacturing name and Lot # on it.

PAYMENT: 25 ADV 25 SUB DRAW 25 Prep Tend/Q 25 Dur EXCU OF W

### REMARKS:

25% Advance with work order, 25% on submission of conceptual drawings, 25% on preparation of quotation / tender, 25% during the execution of work .

LC/TT/IFDBC/FOC # :

ADAMZ

Prepared by  
Incharge

Checked By  
Audit/Accounts

Authorized By  
HO/TD/GM

Approved By  
Director

Print By: ABDUL WALEED

Print Date:8/16/2021 17:35 PM

RDF Name:PO\_PURCHASE\_ORDER

Page 1 of

Head Office/ Plot Survey # 31-36 Tappo Landhi, Bin Qasim Town, District Malir, KarachiKarachi





# Artistic Fabric and Garment Industries (Private) Limited

Manufacturer & Exporter of Denim Fabric & Ready Made Fashion Garments

39/A Block 6 P.E.C.H.S, Shahrā-e-Faisal, Karachi-75400 Pakistan

UAN: (92-21)111004004, 34524411, 34524485

GST: 12-02-6200-003-82, NTN: 0709709-3

Pcm/pur/4/009

Issue#02

Date:11-06-2019

## Standard Purchase Order

Supplier Code : 1273 PO Number(0): 158303  
Supplier: Advance Engineering Associates Purchase Order Date: 07-NOV-20  
Address: Suite # 313 3rd Floor Anum Estate Department: ELECTRICAL  
Shahrā-e-Faisal Muhammad Aslam  
Shelot Karachi PK  
Phone: 021-34311985-6 PR No 73403  
Mobile: Project:  
Email: ae.associates@yahoo Unit: (K2) AGI-2, Plot#71,72, Sector 28, KIA, Karachi.Karachi  
N.T.N: 0775838-3 Bill To: AGI-2, Plot#71,72, Sector 28, KIA, Karachi.Karachi  
S.T.R.N : PI Number:  
Location: AGI - K2 Department(Buyer): Purchase  
Unit Name : Garment Division - K2 Job #  
Status: IN PROCESS Creation Type : Auto Create

S.#	Prefix	Item Description	Detail /	Need by Date	UOM	Qty	Rate (PKR)	DISC	Tax Code	Net Rate (PKR)	Value (PKR)
1	80000	CONSULTANCY SERVICES FOR MODIFICATION & RECTIFICATION OF EXISTING ELECTRICAL SYSTEM AT AGI UNIT Malir M-1			JOB	1.00		0.00			

Total: PKR

### TERMS & CONDITIONS:

If GST/Bill /Commercial Invoice will be sent after 5<sup>th</sup> of the following month, payment will be delayed

Delivery Required Immediately

All goods must be comply with latest version of inditex CTW & MRSL.

All goods delivery must be in original container & original labels include with product name, manufacturing name and Lot # on it.

PAYMENT: 100% Advance

### REMARKS:

Consultancy Services required for Malir M1 PR# 73403 -

NABEEL ZIA

Prepared by  
Incharge

Checked By  
Audit/Accounts

Authorized By  
HO/TD/GM

Approved By  
Director

Print By: NABEEL ZIA

Print Date:11/7/2020 17:57 PM

RDF Name:PO\_PURCHASE\_ORDER

Page 1 of

Garment Division - K2/ AGI-2, Plot#71,72, Sector 28, KIA, Karachi.Karachi



# Artistic Fabric and Garment Industries (Private) Limited

Manufacturer & Exporter of Denim Fabric & Ready Made Fashion Garments

39/A Block 6 P.E.C.H.S, Shahr-e-Faisal, Karachi-75400 Pakistan

UAN: (92-21)111004004, 34524411, 34524485

GST: 12-02-6200-003-82, NTN: 0709709-3

Pcm/pur/4/009

Issue#02

Date:11-06-2019

## Standard Purchase Order

Supplier Code : 1273 PD-Number(0): 158300  
Supplier: Advance Engineering Associates Purchase Order Date: 07-NOV-20  
Address: Suite # 313 3rd Floor Anum Estate Department: ELECTRICAL  
Shahr-e-Faisal Muhammad Aslam  
Shekot Karachi PK  
Phone: 021-34311985-6 PR No 73405  
Mobile: Project:  
Email: ae.associates@yahoo Unit: (K2) AGI-2, Plot#71,72, Sector 28, KIA, Karachi.Karachi  
N.T.N: 0775838-3 Bill To: AGI-2, Plot#71,72, Sector 28, KIA, Karachi.Karachi  
S.T.R.N : PI Number:  
Location: AGI - K2 Department(Buyer): Purchase  
Unit Name : Garment Division - K2 Job #  
Status: IN PROCESS Creation Type : Auto Create

S.#	Prefix	Item Description	Detail /	Need by Date	UOM	Qty	Rate (PKR)	DISC	Tax Code	Net Rate (PKR)	Value (PKR)
1	80000	CONSULTANCY SERVICES FOR MODIFICATION & RECTIFICATION OF EXISTING ELECTRICAL SYSTEM AT AGI UNIT K11			JOB	1.00		0.00			

Total: PKF

### TERMS & CONDITIONS:

If GST/Bill /Commercial Invoice will be sent after 5<sup>th</sup> of the following month, payment will be delayed

Delivery Required Immediately

All goods must be comply with latest version of inditex CTW & MRSL.

All goods delivery must be in original container & original labels include with product name, manufacturing name and Lot # on it.

PAYMENT: 100% Advance

### REMARKS:

Consultancy Servies required for K11 PR# 73405 -

NABEEL ZIA

Prepared by  
Incharge

Checked By  
Audit/Accounts

Authorized By  
HO/TD/GM

Approved By  
Director

Print By: NABEEL ZIA

Print Date:11/7/2020 17:57 PM

RDF Name:PO\_PURCHASE\_ORDER

Page 1 of

Garment Division - K2/ AGI-2, Plot#71,72, Sector 28, KIA, Karachi.Karachi



# Artistic Fabric and Garment Industries (Private) Limited

Manufacturer & Exporter of Denim Fabric & Ready Made Fashion Garments

39/A Block 6 P.E.C.H.S, Shahr-e-Faisal, Karachi-75400 Pakistan

UAN: (92-21)111004004, 34524411, 34524485

GST: 12-02-6200-003-82, NTN: 0709709-3

Pcm/pur/4/009

Issue#02

Date:11-06-2019

## Standard Purchase Order

Supplier Code : 1273 PO Number(0): 158298  
Supplier: Advance Engineering Associates Purchase Order Date: 07-NOV-20  
Address: Suite # 313 3rd Floor Anum Estate Department: ELECTRICAL  
Shahr-e-Faisal Muhammad Aslam  
Shelot Karachi PK  
Phone: 021-34311985-6 PR No 73406  
Mobile: Project:  
Email: ae.associates@yahoo Unit: (K2) AGI-2, Plot#71,72, Sector 28, KIA, Karachi.Karachi  
S.T.N: 0775838-3 Bill To: AGI-2, Plot#71,72, Sector 28, KIA, Karachi.Karachi  
S.T.R.N : P1 Number:  
Location: AGI - K2 Department(Buyer): Purchase  
Unit Name : Garment Division - K2 Job #  
Status: IN PROCESS Creation Type : Auto Create

S.#	Prefix	Item Description	Detail /	Need by Date	UOM	Qty	Rate (PKR)	DISC	Tax Code	Net Rate (PKR)	Value (PKR)
1	80000	CONSULTANCY SERVICES FOR MODIFICATION & RECTIFICATION OF EXISTING ELECTRICAL SYSTEM AT AGI UNIT K1			JOB	1.00		0.00			

Total: PKR

### TERMS & CONDITIONS:

If GST/Bill /Commercial Invoice will be sent after 5<sup>th</sup> of the following month, payment will be delayed

Delivery Required Immediately

All goods must be comply with latest version of inditex CTW & MRSL.

All goods delivery must be in original container & original labels include with product name, manufacturing name and Lot # on it.

PAYMENT: 100% Advance

### REMARKS:

Consultancy Services required for Mailr M1 PR# 73406 -

NABEEL ZIA

Prepared by

Incharge

Checked By

Audit/Accounts

Authorized By

HO/TD/GM

Approved By

Director

Print By: NABEEL ZIA

Print Date:11/11/2020 17:57 PM

PDF Name:PO\_PURCHASE\_ORDER

Page 1 of

Garment Division - K2/ AGI-2, Plot#71,72, Sector 28, KIA, Karachi.Karachi

# Artistic Denim Mills Limited

Plot No. 5-9,23-26 Sector 16,  
Korangi Industrial Area  
Karachi Sindh, Pakistan.

Phone: +92-111-236-236 Fax: +92-21-35054652  
ITN: 0704132-2 GST No: 12-02-5209-003-91  
mail: email@admdenim.com

## WORK ORDER

The following number must appear on all related correspondence, shipping papers, and invoices.

W.O. Number: WO-00068022  
W.O. Date: 04-Nov-2020  
Requested By: Weaving

TO:  
Name: Advance Engineering Associates  
Address: Suit # 313, 3rd Floor, Arjum Estate Shahra-e-Faisal, Karachi Sindh Pakistan.

Phone: 021-34311985-6 Fax:  
ITN: 0775836-3 GST No:  
mail: Ae.associates@yahoo.com CNIC:

SHIP TO:  
Company: Artistic Denim Mills Limited  
Address: Plot No. 5-9,23-26 Sector 16, Korangi Industrial Area Karachi Sindh, Pakistan.  
Phone: +92-111-236-236  
Email: electrical@admdenim.com

Delivery Date	Terms Of Payment	Orderer	Mode of Delivery	Service Terms
Nov-2020	50%Adv	Rizwan Arshad	House Job	Urgent

No.	Item ID	Description	Department	Style	Color	Size	Quantity	Unit	Unit Price (PKR)	Total (PKR)
1	S00070587 CWIP. Serv	Consultancy Charges Electrical Work For Power House ADM Singer Plot	Singer Plot					sq. ft	B	
2	S00070588 CWIP. Serv	Consultancy Charges For Power House Megawatts ADM Singer Plot	Singer Plot				1.00	job		

### Terms and Conditions

Enter this order in accordance with the prices, terms, service method and specifications listed above.  
Please notify us immediately if you are unable to service as specified.

and all correspondence for:  
Artistic Denim Mills Limited

DISCOUNT 0%	0.00
AFTER DISCOUNT	
SALES TAX	0.00
FREIGHT	0.00
OTHER	0.00
<b>TOTAL PKR</b>	<b>620,000.00</b>

SC

\* Quotation Number, AEA/A/0047#7882  
\* Invoice Number.

### A- SCOPE OF SERVICES:

#### Part-1 CONCEPTUAL DESIGN:

- Study and examine the conceptual plan provided by your architect and Machinery suppliers and define electrical works to be carried out to satisfy the system requirement.
- Compute total electrical load requirement inclusive of process lighting and other services and advise means and method of availability of the same from the source.
- Prepare civil layout in auto-cad format of Power House good for structure and civil engineers.



# CONTINENTAL BISCUITS LTD.



Floor # 12, Q.M. Building, Plot # BC-15, Block-7, KDA  
Scheme # 5, Clifton, Karachi.  
Phones: 9221-111-771-771, Fax9221-35147110

## PURCHASE ORDER

<b>Supplier M/s</b> ADVANCE ENGINEERING ASSOCIATES Suite # 313,3rd Floor, Anum Estate, Shahrah-e-faisal Karachi Karachi - P.O.Box:	<b>Purchase Order No</b> : 4500036203 <b>Purchase Order Date</b> : 04.11.2020 <b>Supplier Ref. Docs. No</b> <b>Payment Terms</b> : <b>GST# 01-02-1905-002-73 NTN # 0710106-6</b>
<b>Supplier NTN / CNIC:</b> 0775838-3 / 4220108580349 <b>Delivery Address :</b>	
<b>Please arrange to supply the following:</b>	

Stock Code	Item Description	Unit	Price Per Unit	Quantity	Sales Tax	Value Excl. S.Tax	Delivery Date
	ELECTRICAL CONSULTANCY SERVICES FOR CBL PHASE 111 PROJECT. 3.5% Consultancy Fee Shall Be Charged For Cake Line#10&Line 09 Extension Of Total Electrical/Mechanical Work Executed By Electrical/Mechanical Contractors/Suppliers Engineering Estimate@Rs	AU		1.00	0.00		04.11.2020
	<b>GRAND TOTAL</b>				0.00		

### Transporter Charges

<b>Remarks :</b> 25% Advance 25%On Submission Of Conceptual Drawings 50%Preparation Of Tender/Quote Doc 25%During The Execution Of Work.	<b>Total Value Exclusive Taxes in PKR :</b> <b>Sales Tax Amount :</b> 0.00 <b>Other Charges / Non-Claimable SED :</b> 0.00 <b>Total Purchase Order Value in PKR :</b>
---	--

 <i>Signature</i>	 <i>Signature</i>	 <i>Finance Approval</i>	 <i>Director's Approval</i>
--	---	---	---

### Terms & Conditions :

- All items must be supplied as per specification & subject to approval of our quality control department at Sukkur Factory / Head Office.
- Upon receipt item must have a minimum one year shelf life.
- All invoices must be mailed or directly delivered to the Accounts department.
- PO number must appear on all delivery items, invoices and correspondence.



# CONTINENTAL BISCUITS LTD.

Floor # 12, Q.M. Building, Plot # BC-15, Block-7, KDA  
Scheme # 5, Clifton, Karachi.  
Phones: 9221-111-771-771, Fax9221-35147110



## PURCHASE ORDER

<b>Supplier M/s</b> ADVANCE ENGINEERING ASSOCIATES Suite # 313,3rd Floor, Anum Estate, Shahrah-e-faisal Karachi Karachi - P.O.Box:	<b>Purchase Order No</b> : 4500036203 <b>Purchase Order Date</b> : 04.11.2020 <b>Supplier Ref. Docs. No</b> <b>Payment Terms</b> : <b>GST# 01-02-1905-002-73 NTN # 0710106-6</b>
<b>Supplier NTN / CNIC:</b> 0775838-3 / 4220108580349	
<b>Delivery Address :</b> B-62, S.I.T.E. SHIKARPUR ROAD, SUKKUR	

Please arrange to supply the following:

Stock Code	Item Description	Unit	Price Per Unit	Quantity	Sales Tax	Value Excl. S.Tax	Delivery Date
	ELECTRICAL CONSULTANCY SERVICES FOR CBL PHASE 111 PROJECT. 3.5% Consultancy Fee Shall Be Charged For Cake Line#10&Line 09 Extension Of Total Electrical/Mechanical Work Executed By Electrical/Mechanical Contractors/Suppliers	AU		1.00		1.00	04.11.2020
	<b>GRAND TOTAL</b>				0.00		

### Transporter Charges

<b>Remarks :</b> Rs@200,000/Adv(To Be Adjusted In Running Payments) 25% On Submission Of Conceptual Drawings 50% Preparation Of Tender/Quote Doc 25% During The Execution Of Work.	<b>Total Value Exclusive Taxes in PKR :</b> <b>Sales Tax Amount :</b> 0.00 <b>Other Charges / Non-Claimable SED :</b> 0.00 <b>Total Purchase Order Value in PKR :</b>
---	--

<i>Signature</i>	<i>Signature</i>	<i>Finance Approval</i>	<i>Director's Approval</i>
------------------	------------------	-------------------------	----------------------------

### Terms & Conditions :

- All items must be supplied as per specification & subject to approval of our quality control department at Sukkur Factory / Head Office.
- Upon receipt item must have a minimum one year shelf life.
- All invoices must be mailed or directly delivered to the Accounts department.
- PO number must appear on all delivery items, invoices and correspondence.

# Artistic Denim Mills Limited

Plot No. 5-9,23-26 Sector 16,  
Korangi Industrial Area  
Karachi Sindh, Pakistan.

**Phone:** +92-111-236-236

**Fax:** +92-21-35054652

**NTN:** 0704132-2

**GST No:** 12-02-5709-003-91

**Email:** email@admdenim.com

## WORK ORDER

The following number must appear on all related correspondence, shipping papers, and invoices.

**W.O. Number:** WO-00067349

**W.O. Date:** 21-Oct-2020

**Requested By:** Garments

### TO:

**Name:** Advance Engineering Associates

**Address:** Suit # 313, 3rd Floor, Anum Estate Shahra-e-Faisal, Karachi Sindh Pakistan.

**Phone:** 021-34311985-6

**Fax:**

**NTN:** 0775838-3

**GST No:**

**Email:** Ae.associates@yahoo.com

**CNIC:**

### SHIP TO:

**Company:** Artistic Denim Mills Limited

**Address:** Plot No. 5-9,23-26 Sector 16, Korangi Industrial Area Karachi Sindh, Pakistan.

**Phone:** +92-111-236-236

**Email:** electrical@admdenim.com

Delivery Date	Terms Of Payment	Orderer	Mode of Delivery	Service Terms
21-Oct-2020	30% ADV	Rizwan Arshad	House Job	Urgent

S.No.	Item ID	Description	Department	Style	Color	Size	Quantity	Unit	Unit Price (PKR)	Total (PKR)
1	500070042	Consultancy Service Of Centralized Chiller Water With Air Cooled Electric Operated Chiller For Special Work	ADM-3 (New building)				1.00	job		
	Fees & Sub									

### Terms and Conditions

1. Enter this order in accordance with the prices, terms, service method and specifications listed above.
2. Please notify us immediately if you are unable to service as specified.

Send all correspondence to:  
Artistic Denim Mills Limited

DISCOUNT 0%	0.00
AFTER DISCOUNT	
SALES TAX	0.00
FREIGHT	0.00
OTHER	0.00
<b>TOTAL PKR</b>	



**NAVEENA EXPORTS LIMITED**

**Karachi Denim**

Plot # 1, Sector-28 , Korangi Industrial Area , Karachi

TEL. #: (92-21) 35123104-8 FAX #: (92-21) 5032828

**SERVICE CONTRACT**

I.O. NO : 59294 REVISION 0

STATUS : IN PROCESS

I.O. DATE : 18-AUG-20

PAYMENT TERM : Advance 100%

SUPPLIER : ADVANCE ENGINEERING ASSOCIATES

DELIVERY DATE : 18-AUG-20

FOR DEPARTMENT: ELECTRICAL DEPT

INCOME TAX :

PARTICULARS: ADVANCE PAYMENT OF 200,000, AGREEMENT & FINALIZED FOR 2.75% AMOUNT OF PROJECT AMOUNT FOR CONSULTANCY SERVICES

ORDER NO.	ITEM CODE	ITEM DESCRIPTION	UNIT	P.O. QTY.	RATE	P.O.AMOUNT EXCL.	GST %	G.S.T AMOUNT	EXC %	EXCISE AMOUNT	P.O.AMOUNT INCL.	LOT NO
		ADVANCE PAYMENT AGAINST CONSULTANCY SERVICES PROVIDED AGAINST K-ELECTRIC LOAD ENHANCEMENT FROM 800KW TO 2.8MW IN EXISTING DISTRIBUTION SYSTEM AT M/S. NAVEENA GROUP	Numbers	1.00				0		0		
		<b>TOTAL:</b>						0		0		

Req Num

AMOUNT IN WORDS

Rupees

\*\*\* Contractor must issue ID cards & PPEs to their staff \*\*\*

Department Head

Purchas@.Manager

Approved By

Auditor



Tapal Tea PVT ( LTD )

Plot 40, Sector 15  
Korangi Industrial Area  
Karachi

Att :

Advance Engineering Associates  
Suit 313, 3rd floor  
Karachi  
Tel: 34311985-6  
Fax: 34311987

Vendor No. 1700042

Purchase Order

PO Number 4500037764  
PO Document Date 04.05.2020  
PO Creation Date 04.05.2020  
Currency: PKR  
Please note order number on all documents  
NTN: 0712331-7  
GST: 12-02-0902-001-37  
Tel: +92-21-35063891-4, 5050228-32

S. No	Item	Material Description	Order Quantity	UOM	Unit Price	Units	Net Value
-------	------	----------------------	----------------	-----	------------	-------	-----------

1		Overhauling of 11kV VCB	1.000	AU		1	
---	--	-------------------------	-------	----	--	---	--

Your Quote Ref#AEA/A/0047#7489 Dated: April-21,2020

Details:

30.06.2020 1.000

Note : GST will be charged at actual

Total Value:

Discount :

Other Charges:

Total Purchase Order Value:

PLEASE DELIVER TO

Tapal Tea PVT (LTD)  
Plot-40 Sector 15  
Korangi Industrial Area  
Karachi  
Pakistan

Term of payment: Due after 07 days

PLEASE SEND THE INVOICE TO

Tapal Tea PVT (LTD)  
Plot-40 Sector 15  
Korangi Industrial Area  
Karachi  
Pakistan



# WORK ORDER

Document Number	DAL-AEA-210216
Document Version	01
Effective Date	22-Feb-21



Attn:

Advance Engineering Associates  
Suite # 313, 3rd Floor, Anam Estate,  
Shahrah-e-Faisal Karachi Pakistan.  
Phone No:00-92-21-34311983-6

WORK ORDER NO.	DATE
DAL-AEA-210222	22-Feb-21

This WORK ORDER NO. and date must be quoted in all correspondence.

1. This order is subject to the terms and conditions set out on the face and the Agreement Number: 010221/CKD/MEP-01/AEA/001 dated: Feb-18-2021

Attn : Mr. Rakhshan Ali Khan (CEO)

Please execute the work described below according to the terms and conditions described herein and in the signed agreement"

### Description of work :

FOR DETAILED DESIGN AND DRAWINGS, CONCEPTUAL DESIGN AND DRAWINGS, TOP SUPERVISION AND WARRANTY OF COMPLETE ELECTRIFICATION WORK, SANITATION & PLUMBING WORK AND MEP WORK OF DYSIN AUTOMOBILES LIMITED AT PLOT # 35, BLOCK M, LIEDA, HUB BALUCHISTAN.

### Work Schedule :

Completion Period : 6 weeks Starting Date: 22-Feb-21 Completion Date: 05-Apr-21

S.No.	Description	Amount (Rs.)
1	Mechanical (ACMV) Services	
2	Electrical system with Load Calculations	
3	Power Layout for departments including Welding area, Paint area, Assembling, Cabin Trim, Drilling, Compressor & Etc (As per Layout)	
4	Communication and other Low Voltage System	
5	Earthing & Lightning Protection System	
6	External Electrical Works	
7	Sanitary & Plumbing Services	
8	Fire Protection Services	
9	Air Compressor System	
10	And any other work required under as per the signed agreement	
Total Amount - Lump Sum ( Inclusive of All Taxes)		

### Payment Terms:

- 25% Advance to with the work order.
- 20% Upon Conceptual Design Drawing / Detailed Design Drawing.
- 25% On submission of BOQ Tender Documents / Quotation Documents.
- 20% During the execution of work.
- 10% After completion of the project

We agree to execute the above work according to the terms & conditions specified above and in the Signed Agreement (Attached)

03/03/2021  
Date

Consultant signature

For Dysin Automobiles Limited

Hakim Ali  
Name

Chief Operating Officer  
Position



## LIST OF PROJECTS



## **LIST OF PROJECTS**

### **LIST OF INDUSTRIAL PROJECTS**

1. M/s. Shabbir Tiles Ceramics Limited New Single Kiln Double Fast Firing Line)
2. M/s. Synergies Chemical (Pvt) Limited Hub.
3. M/s. Shell Pakistan Limited, Kemari, Karachi
4. M/s. Tapal Energy – Hub (Office Building)
5. M/s. Vikar Industrial (Pvt) Ltd.
6. M/s. 3M Pakistan (Pvt.) Limited
7. M/s. Roomi Enterprise
8. M/s. Goodwill Textile Mills (Pvt) Ltd
9. M/s. Shell Pakistan Limited
10. M/s. Yunus Textile Mills
11. M/s. Abbass Textile Mills
12. M/s. Friendship Textile Mills (Pvt) Ltd A-5/D, S.I.T.E., Karachi
13. M/s. Kotila Corporation
14. M/s. Experience Jeans Wear in KEPZ (Garment Industry)
15. M/s. Shabbir Tiles & Ceramics Ltd. (Expansion Project-2005)
16. M/s. Shell Pakistan Ltd.
17. M/s. Artistic Milliners – 1
18. M/s. Artistic Milliners – 3 (Spinning Unit)
19. M/s. Yunus Textile Mills (weaving unit extension)
20. M/s. Shell Pakistan – LOBP
21. M/s. Pakistan Metal Industries
22. M/s. Siddique Sons – New Weaving Unit
23. M/s. Artistic Milliners – Denim Unit
24. M/s. Shashi Steel Pipe Works
25. M/s. Yunus Textile Mills (unit – 2)



## **LIST OF INDUSTRIAL PROJECTS**

26. M/s. Yunus Textile Mills (unit – 3)
27. M/s. Kapadia Bela Textile Mills (Hub)
28. M/s. Artistic Denim – 2
29. M/s. Artistic Denim – 1 (Expansion)
30. M/s. Shabbir Tiles (Extension)
31. M/s. Ehtasham Process
32. M/s. Casual Sportswear
33. M/s. Artistic garment industries (washing unit)
34. M/s. Artistic Milliners (pvt) Ltd. (garment unit)
35. M/s. S.B. Textile Mills (Kotri)
36. M/s. Rajwani Denim Mills
37. M/s. Artistic Garment Industries (washing unit)
38. M/s. Artistic Milliner (Pvt.) Ltd. (garment unit)
39. M/s. Artistic Denim Mills (Power House Up-gradation)
40. M/s. Artistic Fabric Mills
41. M/s. Shabbir Tiles & Ceramics Ltd. (4.2 MW Co-Generation Plant)
42. M/s. Shabbir Tiles & Ceramics Ltd. (New Plant at Chaukandi, Bin Qasim)
43. M/s. Siddiqsons Denim City, Hub
44. M/s. Soorty Enterprises Ltd. (Denim Division)
45. M/s. Artistic Fabric Mills
46. M/s. Gul Ahmed Textile Mills Ltd.
47. M/s. Aisha Steel Mills Ltd
48. M/s. Karachi Paper & Board Mills
49. M/s. AG Gigi Industries
50. M/s. PNO Waste Management (MSW Recycling Plant)
51. M/s. Rajwani Apparels



### LIST OF INDUSTRIAL PROJECTS

52. M/s. Artistic Milliner-4, Korangi Ind. Area. (New Garment Unit)
53. M/s. Artistic Denim Mills, Korangi Ind. Area. (Garment Unit)
54. M/s. Artistic Denim Mills, Korangi Ind. Area (Office Block)
55. M/s. Artistic Milliner (AM-5) Shah Latif Town (New Weaving Unit)
56. M/s. Crafter Paper Industries (Admin. Building)
57. M/s. Philips Morris Pakistan, Sahiwal, Pakistan (IBEX Project)
58. M/s. Artistic Denim Mills-New Expansion – 2013
59. M/s. Artistic Denim Mills-Electrical work of finishing & stitching unit
60. M/s. Artistic Denim Mills-Electrical work of new finishing & stitching unit
61. M/s. Artistic Denim Mills-Power House Up-Gradation 2014 at ADM
62. M/s. Artistic Garment Industries-Unit # k-2 & k-Washing Area & New Laser Area
63. M/s. Artistic Milliners- Unit # 14-Electrical Works
64. M/s. Artistic Garment Industries - K-11-Electrical Survey & Designing
65. M/s. Artistic Garment Industries- K-13-Electrical Works (EX. M.F.T)
66. M/s. Al-Karam Towel -Electrical Safety Audit LI & FUNG Unit (D-7,11,31,18 & 40)
67. M/s. Al-Karam Towel (D-10)-Designing of Electrical System for Ro Plant at Super Highway
68. M/s. Al-Karam Towel- Electrical Works of New Air Jet Loom Shed Area on plot D-7
69. M/s. Al-Karam Towel-Power House – 2
70. M/s. Philip Morris Pakistan-Electrical Works for Factory Up-gradation at Sahiwal
71. M/s. Philip Morris Pakistan-Electrical Designing Services of Sahiwal Secondary DEPT
72. M/s. Philip Morris Pakistan-Electrical Works for Secondary Section
73. M/s. Philip Morris Pakistan-Energy Audit at Sahiwal
74. M/s. Philip Morris Pakistan-BMS / GEMT Implementation in Sahiwal
75. M/s. PMI Sahiwal-Electrical Load Enhancement at PMPKL Sahiwal Factory
76. M/s. S.M. Denim-Electrical & Mechanical Work
77. M/s. Artistic Garment Unit, Korangi Ind. Area (Korangi Unit-2&5)
78. M/s. Artistic Garment Unit, Korangi Ind. Area (Korangi Unit-1)



### LIST OF INDUSTRIAL PROJECTS

79. M/s. Artistic Garment Unit, Malir, Karachi. (Malir Unit – 1,2,3,4 & 5)
80. M/s. Artistic Milliner-2, Korangi Ind. Area. (Garment Unit)
81. M/s. Artistic Milliner-2, Korangi Ind. Area. (Weaving Unit)
82. M/s. Artistic Milliner-3, Manzil Pump Landhi. (Spinning Unit)
83. M/s. Artistic Milliner-6, Korangi Ind. Area. (Garment & Washing Unit)
84. M/s. Artistic Milliner-6, Korangi Ind. Area (Garment Washing Unit – 7A, 7B & 7C)
85. M/s. Philip Morris Pakistan - Energy Audit at Sahiwal
86. M/s. Philip Morris Pakistan - Diesel Storage Tank Kotri
87. M/s. D.L. Nash-Electrical Works for Plot: A-54, S.I.T.E,KHI
88. M/s. Artistic Milliners (Units: 1,2,3,4,5,6,7,10A,10B,14,15 & 16)
89. M/s. Artistic Denim Mill-All Units
90. M/s. Artistic Garment Industries-All Units
91. M/s. Artistic Fabric Mills-All Units (1,2,3,4 & 7)
92. M/s. A.G.I. Denim I & II
93. M/s. Continental Biscuits Ltd.
94. M/s. Shabbir Tiles & Ceramics Limited
95. M/s. CRAFTERS POLYPROPYLENE PACKAGES (PVT.) LTD.
96. M/s. Soorty Enterprises (Pvt.) Ltd.
97. M/s. Crown Textile
98. M/s. Agility Logistic, Shah Commercial Complex at Sukkur
99. Mian Nazir Sons Industries (Pvt) Ltd.
100. M/s. Naveena Group
101. M/s. ACME Mills.
102. M/s. Techno Auto Glass.
103. M/s. Siddiqsons Cold Rolling Mills.



### **LIST OF DATA CENTRE PROJECTS**

1. Chaklala Data Centre, Islamabad
2. Orocom (Pvt) Ltd.
3. National Highway Authority (Peshawar-Islamabad Motorway Interchange)
4. Works & Services Department Govt. of Sindh. Hyderabad-Mirpurkhas Dual Carriageway
5. Mitsui & Co. Limited,
6. Liaison Office – Karachi, (Rectification & Renovation of Electrical System)

### **LIST OF TRADING COMPANIES PROJECTS**

1. Sea Traders – Karachi.
2. Pak. Shaheen Container Services
3. FAP MARINE TERMINALS

### **LIST OF BANK PROJECTS**

1. Prime Commercial Bank, Zamzama Branch, Karachi.
2. Habib Bank Ltd. (Facade Lighting Project)
3. Meezan Bank Limited
4. Allied Bank Limited (call center & office)
5. Bank Al-Habib (Design of Branches)
6. Bank Al-Habib (Survey of Branches)

### **LIST OF AUTOMOBILE COMPANIES PROJECTS**

1. Qaim Automotive Mfg. (Pvt) Ltd.
2. Indus Motor Company Ltd. (Kitchen, Store & Jig Shop)
3. Hyundai Motors (D.H.A. Show Room)
4. Indus Motor Company- Canteen Extension
5. Indus Motor Company- Electrical Works for New Commercial Line Building at IMC
6. Protector & Gamble Pakistan



### **LIST OF HOSPITALS PROJECTS**

1. Health Care Hospital
2. Jinnah Hospital Karachi (I.C.U. Building) For Patient Industries (Pvt) Ltd.
3. Dow. University (Ojha Campus (Principal Cons. Y.H. Ass.)

### **LIST OF PHARMACEUTICALS PROJECTS**

1. Parke Davis Electrification up gradation project 1999
2. Lever Brothers
3. Helix Pharma – Survey & Analysis- 2006
4. Indus Pharma (Pvt) Ltd. - Head Office Building (Up-gradation & Rectification of Electrical System)
5. Abbott Laboratories (Pak) Limited (Up-gradation of Sterilized Area)
6. Abbott Laboratories (Pak) Limited (Up-gradation of Tablet Finishing)
7. Abbott Laboratories (Pak) Ltd. (1.1 M.W, Co-Generation-2)
8. Abbott Laboratories (Pakistan) Ltd. Up-Grade Project – 2000
9. Abbott Laboratories Pakistan Ltd
10. Abbott Laboratories Pakistan Ltd. (Expansion of MIS Dept and Up-gradation)
11. Platinum Pharma Limited
12. Platinum Pharma (Power Enhancement)



### LIST OF PHARMACEUTICALS PROJECTS

1. Abbott Laboratories (Pak) Limited
2. Royal Pharmaceuticals (Pvt) Ltd
3. Clariant Pakistan Ltd. (Jamshoro)
4. Platinum Pharmaceuticals (Pvt) Ltd
5. Clariant Pakistan, Korangi Ind. Area. (Warehouse & Master Batch)
6. CCPL -Solar Works at Head office KHI.
7. CCPL-Electrical & HVAC Works for LAB at KHI
8. CCPL (Lahore) - Feasibility Report of Up-Gradation Rectification & Modification
9. Byco Oil Pakistan - Rectification of U.P.S power distribution to work station
10. Procter & Gamble-Electrical Work of Warehouse and Gate House at Port Qasim
11. Bayer Pakistan (Pvt) Ltd.
12. Healthtek (Pvt.) Ltd.
13. Pfizer Pakistan



### **LIST OF FOOD INDUSTRIES PROJECTS**

1. A & W Restaurant
2. Continental Biscuits Limited-(New Line 3 & Warehouse Expansion)
3. Habib Oil Mills (Pvt) Ltd.
4. Habib Oil Mills (New Refinery)
5. Hamid Flour Mills (Sukkur)
6. Continental Biscuit Limited – Sukkur, Sindh. (Plant Up-Gradation)
7. Tasty Farm, Nooriabad, Pakistan
8. Dairy Land (Poultry) Electrical Works of layer-2 & Rectification of existing system
9. Dairy Land (Milk Plant) Up-Gradation & Rectification of Electrical System at Dhabeji
10. Hamid Flour Mills-2022
11. Matco Food Ltd-2022
12. Sukkur Beverages-2022

### **LIST OF RESIDENTIAL & COMMERCIAL PROJECTS**

1. Residence of Mr. Anwar
2. Residence of Mr. Anis
3. Residence of Mr. Shahneela Shahid
4. Residence of Mr. Suhail Haji Younus
5. Residence of Mr. Nadeem Najmi
6. Residence of Mr. Hyder Naqvi, Defence Housing Society – Karachi.
7. Fortune House- (Defence Housing Society, Karachi)
8. Prime Minister Housing Program for (Ganjo Talker Hyderabad)
9. Residence of Mr. Nadeem Bashir (ISL)
10. Residence of Mr. Naveed Malik (LHR)
11. Residence of Mr. Istiaq Roomi
12. Dream World Hotel & Resort
13. Gillani Mega Mall, Quetta



### LIST OF RESIDENTIAL & COMMERCIAL PROJECTS

1. Baba-E-Mega Heights, Quetta
2. Emaar (Plot No. 7 & 8)
3. Avari Towers (Islamabad) (Principal Consultant. Y.H. Ass.)
4. PHA Maymar 1 & 2.
5. World Trade Centre (Islamabad)
6. World trade Center-Islamabad Pakistan- Electrical & Plumbing Works
7. Maymar City Shopping Centre
8. Sohni Golf-Electrical & Plumbing Works
9. Shangrila (Islamabad)-Electrical & Plumbing Works
10. Shangrila (Islamabad)-HVAC & Plumbing Work
11. Fatima Golf City Karachi Electrical Works
12. Crescent Bay-Infrastructure
13. Bahria Town-Designing of I.T. & Security System at Park Lane Tower ISL.
14. Galleria Inclave Bahria-Site Office
15. Galleria Inclave Bahria-MEP Works
16. Speed Pvt Ltd-Electrical & HVAC Design at Emporium Mall Lahore
17. Omega Mall-Electrical Works
18. Dominos Pizza Outlet-MEP works of outlets at different location of KHI & HYD
19. Hilton Residency-Electrical & Plumbing Works for Hilton Residency at Sindhi Muslim Co-Operative Housing Society, Karachi
20. Maymar Pride.
21. The Galleria.
22. M/s. PLT Islamabad.
23. Haroon Premier MEP (Mechanical, Electrical & Plumbing) Works of Haroon Premier Mall and Residency at Karachi.
24. Naya Nazimabad Housing Scheme Block A,B,C & D
25. Sohni Saiban
26. LA-Casa One Mall & Residencia



### LIST OF MEDIA HOUSE PROJECTS

1. Channel Tek – Electrical works for Office Building of Syed Mubashir Imam DHA Khi
2. Eastern Film Studio
3. G.H. Thavar & Co. (Pvt) Ltd.
4. ITIM (Office Building)
5. Nue-Multiplex-Square-at D.H.A. Karachi.
6. Nue-Multiplex-Askari-IV at Gulistan-E-Jauhar-Electrical works



## LIST OF DUBAI PROJECTS

1. Proposed Building G+6P+H.C.+46RES.+DUPLEX (Sharjah, UAE)
2. Proposed Residential G+7P+H.C+35+DUPLEX)
3. Proposed Office & Residential (G+35) (Sharjah, UAE)
4. Proposal Building B+G+5P+HC+44 Typical + HELIPAD. (Sharjah, UAE)
5. Dubai Mall-Electrical Works
6. Spinneys, King Faisal Road, UAE Supermarket in Sharjah
7. Spinneys, King Faisal Road, UAE Supermarket in Dubai
  
8. **H.E. SULTAN KHALIFA AL HABTOOR Tower-1 AT UAE-SHARJAH** **In Progress**  
**M.EP WORKS FOR BUILDING 1**  
PRO (G+3P+1ST TYPICAL (RESI.FL+H.C) + 21 TYP. FLOORS + 1 TECH.FLOOR) PROJECT OF H.E. SULTAN KHALIFA AL HABTOOR AT UAE-SHARJAH
  
9. **H.E. SULTAN KHALIFA AL HABTOOR Tower-2 AT UAE-SHARJAH** **In Progress**  
**M.EP WORKS FOR BUILDING 1**  
PRO (G+3P+1ST TYPICAL (RESI.FL+H.C) + 21 TYP. FLOORS + 1 TECH.FLOOR) (AL-Qasimiyah)
  
10. **ALIA TOWER - UAE-SHARJAH** **In Progress**  
M.E.P WORKS FOR AL-ALIA TOWER PRO (G+6P+1ST TYPICAL (H.C) + 34 TYP. Floor+1 TECH FLOOR AT SHARJAH M.E.P WORKS FOR AL-ALIA TOWER PRO (G+6P+1ST TYPICAL (H.C) + 34 TYP. Floor+1 TECH FLOOR AT SHARJAH
  
11. **AL ALIA PLOT-DA7/009** **In Progress**  
ELECTRICAL WORKS FOR AL-ALIA TOWER PLOT NO. DA7/1239 AT AL KHAN AREA-SHARJAH



**LIST OF K.E AND WAPDA CONNECTION FOR THE FOLLOWING**  
**INDUSTRIAL UNIT PROJECTS**

1.	Artistic Milliners Pvt. Ltd. Unit # AM-02	4.6MW KE Connection
2.	Artistic Milliners Pvt. Ltd. Unit # AM-03	4.7MW KE Connection
3.	Artistic Milliners Pvt. Ltd. Unit # AM-04	4.7MW KE Connection
4.	Artistic Milliners Pvt. Ltd. Unit # AM-15	1.9 to 3.6MW KE Connection
5.	Artistic Milliners Pvt. Ltd. Unit # AM-16	4.7MW KE Connection
6.	Artistic Fabric Mills (Pvt.) Ltd. Unit # 1	3.5MW KE Connection
7.	Soorty Enterprises (Private) Limited	4-5MW KE Connection
8.	Shabbir Tile & Ceramics Unit-1	2.7 MW KE Connection
9.	Shabbir Tile & Ceramics Unit -2	4-5 MW KE Connection
10.	Artistic Garment Industries (AGI Denim -I)	2.5MW to 5MW KE Connection
11.	Artistic Garment Industries (AGI Denim -II)	4.5MW KE Connection
12.	Artistic Garment Industries (AGI Unit K-2 & K-5)	4MW KE Connection
13.	FAP Marine Terminals Port, Bin Qasim.	1.25MW to 3.15MW
14.	Artistic Denim Mills Ltd.	4.9 M.W K-Electric
15.	Artistic Denim Mills	3.9 M.W K-Electric
16.	Artistic Garment Industries (Malir Unit # 1,2,3 # 4)	1.6MW KE Connection
17.	Continental Biscuits Limited	4.8MW WAPDA Connection
18.	Sukkur Beverages	WAPDA Connection



### LIST OF PLUMBING DESIGN PROJECTS COMPLETED

1. Pak. Shaheen Container Service
2. PHA Maymar PHASE 1
3. Sarina Tower
4. PHA Maymar Sec-U
5. World Trade Centre
6. Silver Sand
7. Millennium Shopping Mall (Maree)
8. Meridian Shopping Mall (Mal Road Rawalpindi)
9. Aman Foundation
10. Gul Plaza Shopping Mall (Karachi)
11. Embassy Hotel (Karachi)
12. K.E.S.C. Building Karachi.
13. IOBM College / School
14. State Bank Library Building Karachi.
15. Laksan Tobacco Factory
16. A. J. K. Hospital Muzaffarabad
17. A.L.K. Hospital Rawalkot
18. UNION CLUB Karachi
19. KFC Branche's



## **LIST OF CLIENTS FOR DESIGN AND OPTIMIZATION FOR PV AND BESS (MICROGRID) PROJECTS**

### **LIST OF COMPLETE AND RUNNING PROJECTS**

1. M/s. Continental Biscuits Ltd. Sukkur
2. M/s. Continental Biscuits Ltd-Karachi Head Office
3. M/s. Artistic Denim Mills -Karachi
4. M/s. Artistic Milliners (Pvt.) Ltd.-Karachi.
5. M/s. Artistic Garment Ind. (AGI Denim) (Pvt.) Ltd-Karachi
6. M/s. Al-Karam Towel Industries -Karachi.
7. M/s. Khas (Pvt.) Ltd -Karachi.
8. M/s. Sohni Golf View Apartment-Karachi.
9. M/s. Fatima Golf City-Karachi.
10. M/s. P.H.A. Maymar-Karachi.
11. M/s. Philip Morris (Pakistan) Ltd.-Sahiwal
12. M/s. Philip Morris (Pakistan) Ltd.-Kotri
13. M/s. Dairy Land Pvt. Ltd-Jhampir
14. M/s. Dairy Land Pvt. Ltd-Nooria
15. M/s. Shangrila Comforts – Islamabad
16. M/s. Artistic Fabric Mills (Pvt.) Ltd.
17. M/s. Speed Private Ltd. (Brands Outlet) Lahore
18. M/s. The Galleria-Bahria Enclave –Islamabad
19. M/s. Domino's Pizza-Karachi.
20. M/s. Omega Mall-North Karachi.
21. M/s. Nue Multiplex-Karachi.
22. M/s. Marvi Rice Processing Plant PQA-Karachi.
23. M/s. Marvel Agro Commodities -Karachi.
24. M/s. Byco Oil Pakistan Limited-Karachi
25. M/s. Byco Oil Pakistan Limited-Karachi.
26. M/s. Procter & Gamble Pakistan-Karachi
27. M/s. Hilton Residency -Karachi.
28. M/s. S.M. Denim Mills-Karachi



## LIST OF CLIENTS FOR DESIGN AND OPTIMIZATION FOR PV AND BESS (MICROGRID) PROJECTS

### LIST OF COMPLETE AND RUNNING PROJECTS

29. M/s. Maymar City Shopping Centre
30. M/s. D.L. Nash
31. M/s. Fatima Golf City Karachi
32. M/s. Sukkur Beverages
33. M/s. Hamid Flour Mills
34. M/s. Matco Food Ltd.
35. M/s. AJ Textile, Sawabi (Hub Engineering)
36. M/s. Clariant Pakistan Ltd.
37. M/s. Nagaria Textile Mills Limited.
38. M/s. Residential Projects
39. M/s. United Medical Dental College
40. M/s. Soorty Enterprises (Private) Limited
41. M/s. Shabbir Tile & Ceramics Unit-1
42. M/s. Umer Spinning Mill (Hub Engineering)
43. M/s. Fap Marine Terminals Port.
44. M/s. Mian Nazir Sons Industries-Karachi
45. M/s. Pfizer Pakistan
46. M/s. Sohni Saiban
47. M/s. La-Casa One Mall & Residencia
48. M/s. Hamid Flour Mills
49. M/s. Indus Lyallpur-Faislabad-(Hub Engineering)
50. M/s. Naya Nazimabad Housing Scheme  
(Comm-184 & Comm109-1)

**A.E.A. INTERNATIONAL (PVT.) LTD.**

**LIST OF PROJECTS IN HAND**

<b>S.No.</b>	<b>CLIENT NAME</b>	<b>WORK DESCRIPTION</b>
1	LACASA Builders & Developers	Electrical Works for Lacasa One Shopping Mall Karachi.
2	NOBLE PVT LTD.	Electrical Works of Sohni Saiban, Karachi.
3	Consultair-Dubai- Habtoor	MEP WORKS FOR BUILDING 1 PRO (G+3P+15T TYPICAL (RESI.FL+H.C) + 21 TYP. FLOORS + 1 TECH.FLOOR) PROJECT OF H.E. SULTAN KHALIFA AL HABTOOR AT UAE-SHARJAH
4	Consultair-Dubai- Alia Tower	M.F.P WORKS FOR AL-ALIA TOWER PRO (G+6P+15T TYPICAL (H.C) + 34 TYP. Floor+1 TECH FLOOR AT SHARJAH
5	Consultair- Al Alia Plot-DA7/009	ELECTRICAL WORKS FOR AL-ALIA TOWER PLOT NO. DA7/1239 AT AL KHAN AREA-SHARJAH
6	CROWN TEXTILE LTD.	ELECTRICAL AND MECHANICAL WORKS OF M/S. CROWN TEXTILE LTD AT SURVEY # 232 TO 502, BIN QASIM
7	Continental Biscuit (Pvt.) Ltd.	4.8MW WAPDA CONNECTION FOR LOAD ENHANCEMENT & UP GRADATION / MODIFICATION OF EXISTING POWER DISTRIBUTION SYSTEM OF PRODUCTION AT M/S. CBL SUKKUR-SINDH.
8	Artistic Fabric Mills (Pvt.) Ltd	ELECTRICAL WORKS OF AFM- UNIT # 7 SHAH LATIF TOWN, KARACHI.
9	M/S. Artistic Garment Industries	02 M.W To 04 M.W K-Electric Connection for Load Enhancement & Up-Gradation / Modification of Existing Power Distribution System at AGI Unit K-1
10	M/S. Artistic Garment Industries	1.6 M.W K-Electric Connection for Load Enhancement & Up-Gradation / Modification of Existing Power Distribution System at AGI Malir Units M-1, M-2, M-3 & M-4
11	M/S. Artistic Garment Industries	Distribution between AGI Denim-I & II Shah Latif Town Karachi.
12	M/S. Artistic Garment Industries	EXPANSION 2024 WORK AT AGI DENIM - II, SHAH LATIF TOWN KARACHI
13	Artistic Fabric Mills	Electrical Modification of Existing and New Electrical Works at AFM Units, AFM-1 K.E. Power Supply, AFM-2 K.E. Power Supply, AFM-7 Denim City, & AFM-8, (4Nos. Unit.
14	Open door design studio & workshop	Electrical Works for FLAMME at Nue Multiplex & Entertainment Square, D.H.A. Karachi.
15	Amatullah Aai Saheba memorial trust	Electrification Works and Solar System with Battery Energy Storage System at Muhammadi Park Housing Scheme for Phase-1 & 2, Malir, Karachi
16	Arch vision plus	Electrical Work For 1 No. 6.4MW Wartsila HFD Genset at Soorty Enterprises, Shah Latif Town, Karachi.
17	Soorty Enterprises (Pvt.) Ltd	Electrical Work For 1 No. 6.4MW Wartsila HFD Genset at Soorty Enterprises, Shah Latif Town, Karachi.
18	Motif Textile	Electrical Survey and Determine Solar Potential for Motif Tex Style at F.B. Area, Karachi.
19	Pearl fabrics	Electrical Survey and Determine Solar Potential For Pearl Fabrics at Korangi Industrial Area, Karachi.
20	Speed (Pvt.) Ltd	Modification of Existing HVAC & Electrical system for Hush Puppies Store at Lucky One Mall Karachi
21	Khas Industries (Pvt.) Ltd	360KW Solar System and Rectification with Modification of Electrical System at Khas Industries (Pvt.) Ltd., Korangi Industrial Area

**A.E.A. INTERNATIONAL (PVT.) LTD.**

**LIST OF PROJECTS IN HAND**

<b>S.No.</b>	<b>CLIENT NAME</b>	<b>WORK DESCRIPTION</b>
22	A.A. Associates	Electrical (MV, LV. & ELV System), Fire Fighting, Ventilation and Solar System design Works for Warehouses Located at Mega Bird Enterprises.
23	Taj Gasoline	Electrical Designing Work for Taj Gasoline Pump station # Taj-26 Hyderabad & Taj-83 Saeedabad, Pakistan.
24	SMM & CO.	KPS School branches
25	Premier Builders	MEP (Mechanical, Electrical & Plumbing) Work for Apartment Building on Plot No - 1 Sector - 4C Deh, Songal Scheme – 33
26	Dream world Resort Hotel & Golf Course	RECTIFICATION WORK ON POWER DIST. SYSTEM AT DREAMWORLD RESORT.
27	MAERSK PAKISTAN (PVT) LTD.	As-Installed drawing, SLD (single line diagram) and site plan with M.V Feeder Routes for Maersk Pakistan
28	The Design Loft	Flamme Restaurant-The Place Karachi
29	Saifiyah Boys High School	Safety Audit of Electrical System & Designing of Solar System at Saifiyah Boys High School Karachi.
30	Artistic Garment Ind. (AGI Denim) (Pvt.) Ltd.	M.E.P Works for AGI – Garment Washing Unit, Korangi Industrial Area, Karachi.
31	Artistic Garment Ind. (AGI Denim) (Pvt.) Ltd.	Electrical Work of New Office Block at AGI K-14, Korangi Industrial Area, Karachi.
32	Ghandhara Industries Limited	M.E.P Works for new Bus Body Fabrication line-PEB Shed (002) at Ghandhara Industries Limited, S.I.T.E Area Karachi.
33	IDEAS (PVT.) LTD. (Gul Ahmed)	ELECTRICAL AUDIT & SAFETY SURVEY AT IDEAS OUTLET CLIFTON, KARACHI
34	Hamdard Laboratories (Waqf) Pakistan	Electrical Work of OSD Expansion Work at Hamdard Industrial Complex, Hub, Karachi.
35	Karimi Glass Towers	Mechanical, Electrical, & Plumbing (MEP) Works for Karimi Glass Tower at Plot # 46, Surjani Town, Karachi.
36	IDEAS (PVT.) LTD. (Gul Ahmed)	ELECTRICAL AUDIT & SAFETY SURVEY AT IDEAS OUTLET BUREWALA, MULTAN-PAKISTAN



**A.E.A INTERNATIONAL (PVT.) LIMITED**  
**PLANNERS & CONSULTING ENGINEERS**

## UNITED ARAB EMIRATES PROJECTS



Al Alia Tower - Sharjah



Building DA9 - Sharjah



Spinneys - Dubai



Spinneys - Sharjah



**A.E.A INTERNATIONAL (PVT.) LIMITED**  
**PLANNERS & CONSULTING ENGINEERS**

## UNITED ARAB EMIRATES PROJECTS



Al Habtoor Tower 1 - Sharjah



Al Habtoor Tower 2 - Sharjah



Dubai Mall - Dubai



AL Alia Plot - DA7 - Sharjah



**A.E.A INTERNATIONAL (PVT.) LIMITED**  
**PLANNERS & CONSULTING ENGINEERS**

## INDUSTRIAL PROJECTS



Artistic Fabric Mills



Artistic Milliners



Artistic Garment Industries



ADM DENIM



**A.E.A INTERNATIONAL (PVT.) LIMITED**  
**PLANNERS & CONSULTING ENGINEERS**

## INDUSTRIAL PROJECTS



D.L. Nash

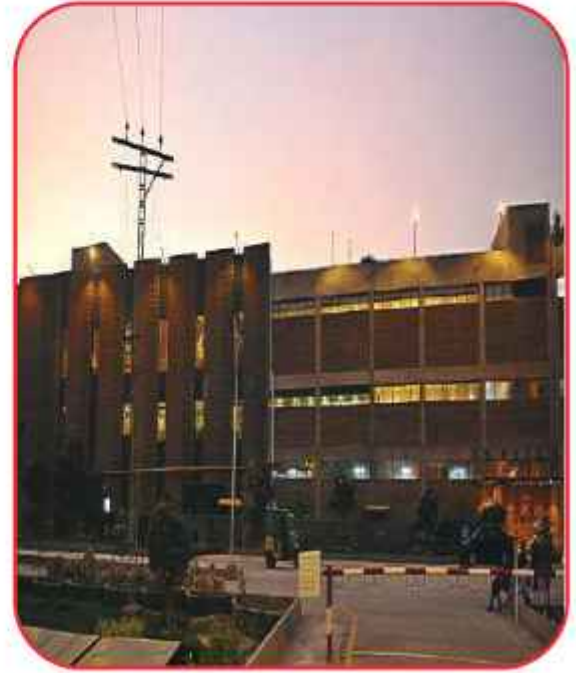

Continental Biscuits Ltd



Crafters (Pvt) Ltd



Naveena Group



**A.E.A INTERNATIONAL (PVT.) LIMITED**  
**PLANNERS & CONSULTING ENGINEERS**

## INDUSTRIAL PROJECTS



**Soorty Enterprises Ltd**



**Gul Ahmed Textile Mills Ltd.**



**Philips Morris Pakistan**



**Al-Karam Towel**



**A.E.A INTERNATIONAL (PVT.) LIMITED**  
**PLANNERS & CONSULTING ENGINEERS**

## RESIDENTIAL & COMMERCIAL PROJECTS



Dream World Hotel & Resort



Gillani Mega Mall



Emaar



Avari Towers



## CERTIFICATES FROM CLIENTS

February 12, 2024

**M/S A.E.A INTERNATIONAL (PVT.) LTD.**  
Suite # 313, 3rd Floor, Anum Estate,  
Shahrah-e-Faisal,  
Karachi- Pakistan

Attention: **Mr. Rakhshan Ali Khan**  
(Chairman)

Subject: **AWARD OF CONSULTANCY SERVICES FOR 1.5 MW SOLAR PROJECT  
AT AGI DENIM UNITS # 01**

Dear Sir,

We are pleased to inform you that after careful consideration and evaluation of the proposals submitted for the consultancy services related to our upcoming solar project, Artistic Garment Industries (AGI Denim) (Pvt.) Ltd. has decided to award the contract to your esteemed firm.

The consultancy scope of services will cover the following key areas:

- System Design and Engineering
- Feasibility Study and Site Assessment
- Procurement Assistance and Vendor Evaluation
- Project Management Support
- Performance Monitoring and Optimization

We expect to work closely with your team throughout all phases of the project, from initial planning to post-implementation evaluation.

We look forward to collaborating with you on this exciting project and are confident that your expertise will contribute to its success. Please do not hesitate to contact us should you have any questions or require further information at this stage.

Sincerely,  
ARTISTIC GARMENT INDUSTRIES (AGI DENIM) (PVT.) LTD.

  
Shahab Ahmed  
Project Head





**A.E.A INTERNATIONAL (PVT.) LIMITED**  
**PLANNERS & CONSULTING ENGINEERS**

Ref No. AEAI/B/2024#1159

August 26, 2024

**M/S. ARTISTIC GARMENT INDUSTRIES**  
**(AGI DENIM) (PVT.) LTD.**  
Landhi Bin Qasim Town,  
Karachi, Pakistan.

**Subject: REQUEST FOR ACKNOWLEDGMENT OF COMPLETED SERVICES**

Dear Sir,

We are pleased to inform you that we have successfully completed the consultancy services for 1.5MW Solar Project at unit AGI Denim Unit-1, Shah Latif Town, Karachi.

The scope of services has been executed in full compliance with the agreed terms and timelines. We kindly request your acknowledgment of the completion of these services.

Should you require any further clarifications or documentation, please feel free to contact us.

Sincerely,

M/s A.E.A International (Pvt.) Ltd.

M/s Artistic Garment Industries  
(AGI Denim) (Pvt.) Ltd.

Name: Suhaib-Ul-Mukhtar

Name: Mr. Shahab Ahmed

Designation: C.E.O

Designation: Project Head

Signature: 

Signature: 

**PROJECT COMPLETION CERTIFICATE FOR**  
**1.5 MW SOLAR CONSULTANCY**

**To Whom It May Concern**

This letter formally recognizes and appreciates the excellent consultancy services provided by M/s. A.E.A. International (Pvt.) Ltd. for the successful completion of the 1.5-MW Solar Project at our AGI Denim Unit 01, at Shah Latif Town, Karachi.

We are pleased to confirm that the system is performing as expected, delivering energy outputs in line with projections. This achievement is a testament to the exceptional standards, technical proficiency, and professionalism demonstrated by your organization.

Regards,

  
Shahab Ahmed  
Project Head



**M/s. Artistic Garment Industries  
(AGI Denim) (Pvt.) Ltd.**

M/s A.E.A International (Pvt.) Ltd.  
Suite # 313, 3rd Floor, Anum Estate,  
Shahrah-e-Faisal-Karachi  
Pakistan.

**Dated: 18<sup>th</sup> December, 2023**

Subject: **Award of Consultancy Services for 2.4 MW Solar Project at our Indus Lyallpur, Faisalabad**

Dear Sir,

After a careful evaluation of the proposal submitted for the consultancy services related to our upcoming solar project, the management has found that your proposal demonstrated a comprehensive understanding of the project requirements, as well as the expertise and experience necessary to ensure its successful execution. Therefore, we are pleased to inform you that your firm has been selected as consultant for our upcoming **2.4 MW Solar Project** to be installed at **Indus Lyallpur, Faisalabad**. The mutually agreed consultancy fee is **PKR 1.15 per watt**, covering the following key services:

- Comprehensive Report on Site Assessment
- System Design and Engineering
- Vendor Evaluation
- Verification of approved material.
- Contractors Work Monitoring
- Periodic Work Progress Report

We expect that with your expertise in the field of renewable energy and the experience of your team, the project will be completed in the given timeline.

Please do not hesitate to contact us should you have any questions or require further information at this stage.

Sincerely,

Zubair Sultan  
Manager Sales & Operation  
Hub Engineering Pvt Ltd.



**Postal Address**

**Head Office**  
397-B, Faisal Town,  
Lahore-Pakistan.  
Tel: +92 42 35218643

**Karachi Office:**  
C/174 Block 9,  
Gulshan-E-Iqbal, Karachi.  
Tel: +92 332 360 0856



**A.E.A INTERNATIONAL (PVT.) LIMITED**  
**PLANNERS & CONSULTING ENGINEERS**

M/s Hub Engineering (Pvt.) Ltd.  
897B, Faisal Town,  
Lahore,  
Pakistan.

Dated: 30<sup>th</sup> August, 2024

Subject: Request for Acknowledgment of Completed Services

Dear Sir,

We are pleased to inform you that we have successfully completed the consultancy services as outlined in Purchase Order # PO-23-0002 for the 2.4 MW Solar Project at Indus Lyallpur, Faisalabad.

The scope of services has been executed in full compliance with the agreed terms and timelines. We kindly request your acknowledgment of the completion of these services.

Should you require any further clarifications or documentation, please feel free to contact us.

Sincerely,

M/s A.E.A International (Pvt.) Ltd.

Name: Mr. Suhaib-Ul-Mukhtar



Designation: C.E.O

Signature: 

Date: 30-08-2024

M/s Hub Engineering (Pvt.) Ltd.

Name: Zubair Sultan

Designation: Manager Operations

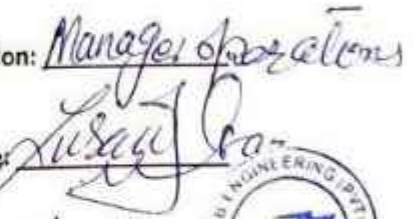
Signature: 

Date: 07/09/24





Power Control  
Automation Company

- Genset Synchronization
- PV Diesel Control Solutions
- Onsite/In-house Training Services
- Solar Structure & Installation
- Automation & Control Systems
- Power & Control Panels

# CERTIFICATE OF COMPLETION

## To Whom It May Concern

This is to formally acknowledge and appreciate the outstanding consultancy services provided by **M/s A.E.A International (Pvt.) Ltd.** for the successful completion of the **2.4 MW Solar Project at Indus Lyallpur, Faisalabad.**

We are pleased to confirm that the system is performing optimally, delivering energy outputs as projected. This achievement reflects the exceptional best practices, technical expertise, and professionalism demonstrated by your team throughout the project.

Your dedication to quality and meticulous attention to detail have been instrumental in ensuring the success of this project. We commend your efforts and look forward to future collaborations.

Issued by:

Zubair Sultan  
Manager Sales & Operation  
M/s Hub Engineering Pvt Ltd



### Postal Address

Head Office  
897-B, Faisal Town,  
Lahore-Pakistan.  
Tel: +92 42 35218643

Karachi Office:  
C/174 Block 9,  
Gulshan-E-Iqbal, Karachi.  
Tel: +92 332 360 0856

info@hubengineering.pk  
 www.hubengineering.pk



**Mian Nazir Sons Industries (Private) Ltd.**  
**Manufacturers: Synthetic Sacks**



Dated: 18-10-2021

**M/S. A.E.A. INTERNATIONAL (PVT.) LTD.**  
Suite # 313, 3rd Floor, Anum Estate,  
Shahrah-e-Faisal, Karachi- Pakistan.

Subject: **Award of Consultancy Services for 01-MW Solar Project at Mian Nazir Sons Industries**

Dear Sir,

We are pleased to inform you that after careful consideration and evaluation of the proposals submitted for the consultancy services of 01MW related to our upcoming solar project, M/s Mian Nazir Sons Industries has decided to award the contract to your esteemed firm.

Your proposal demonstrated a comprehensive understanding of the project requirements, as well as the expertise and experience necessary to ensure its successful execution.

The consultancy scope of services will cover the following key areas:

- Feasibility Study and Site Assessment
- System Design and Engineering Vendor Evaluation
- Verification of approved material.
- Contractors Work Monitoring
- Periodic Work Progress Report

We expect that you are able to complete the whole jobs or services with your engineer expertise in given time frames.

Thanking you,

**For Mian Nazir Sons Industries (Pvt.) Ltd.**

  
**MIAN NAZIR SONS IND. (PVT) LTD.**

**Imran Shaukat**  
Director

**HEAD OFFICE:**

Business Centre 3rd Floor (301-307),  
Mumtaz Hassan Road, Off, I.I Chundrigar Road  
Karachi-Pakistan.  
Tel: 92-21-32412982-85, Fax: 92-21-32421400  
Email: imran@miannazirsons.com, URL: www.miannazirsons.com

**FACTORY:**

Plot # 85, Mouza Pathera  
Hub Chowki, District Lasbela  
Balochistan.  
Ph: 0853-363874, 363232  
Fax: 0853-364027  
Email: ho@miannazirsons.com



**A.E.A INTERNATIONAL (PVT.) LIMITED**  
**PLANNERS & CONSULTING ENGINEERS**

Mian Nazir Sons Industries (Pvt.) Ltd.  
Business Centre, 3d Floor (301-307),  
Mumtaz Hassan Road, Off. I.I. Chundrigar  
Road, Karachi-Pakistan.

Dated: 15<sup>th</sup> October, 2024

Subject: Request for Acknowledgment of Completed Services

Dear Sir,

We are pleased to inform you that we have successfully completed the consultancy services as outlined in Purchase Order # NIL for the 01-MW Solar Project at Mian Nazir Sons Industries, Plot # 85, Mauza Pathera, Hub Chowki, District Lasbela, Baluchistan.

The scope of services has been executed in full compliance with the agreed terms and timelines. We kindly request your acknowledgment of the completion of these services.

Should you require any further clarifications or documentation, please feel free to contact us.

Sincerely,

M/s A.E.A International (Pvt.) Ltd.

Name: Mr. Rakhshan Ali Khan

Designation: Chairman

Signature: [Handwritten Signature]

Date: 15-10-2024

M/s Mian Nazir Sons Industries (Pvt.) Ltd.

Name: Mr. Imran Shaukat

Designation: CEO

Signature: [Handwritten Signature]

Date: 26-12-2024

**MIAN NAZIR SONS IND. (PVT) LTD.**

June 06, 2022

M/S A.E.A INTERNATIONAL (PVT.) LTD.  
Suite # 313, 3rd Floor, Anum Estate,  
Shahrah-e-Faisal,  
Karachi- Pakistan

Attention: Mr. Rakhshan Ali Khan  
(Chairman)

Subject: AWARD OF CONSULTANCY SERVICES FOR 03 MW SOLAR PROJECT  
AT AGI DENIM UNITS # 02

Dear Sir,

We are pleased to inform you that after careful consideration and evaluation of the proposals submitted for the consultancy services related to our upcoming solar project, Artistic Garment Industries (AGI Denim) (Pvt.) Ltd. has decided to award the contract to your esteemed firm.

The consultancy scope of services will cover the following key areas:

- System Design and Engineering
- Feasibility Study and Site Assessment
- Procurement Assistance and Vendor Evaluation
- Project Management Support
- Performance Monitoring and Optimization

We expect to work closely with your team throughout all phases of the project, from initial planning to post-implementation evaluation.

We look forward to collaborating with you on this exciting project and are confident that your expertise will contribute to its success. Please do not hesitate to contact us should you have any questions or require further information at this stage.

Sincerely,  
ARTISTIC GARMENT INDUSTRIES (AGI DENIM) (PVT.) LTD.

  
Shahab Ahmed  
Project Head



**A.E.A INTERNATIONAL (PVT.) LIMITED**  
**PLANNERS & CONSULTING ENGINEERS**

Ref No. AEAI/B/2024#1114

February 10, 2024

**M/S. ARTISTIC GARMENT INDUSTRIES**  
**(AGI DENIM) (PVT.) LTD.**  
Landhi Bin Qasim Town,  
Karachi, Pakistan.

**Subject: REQUEST FOR ACKNOWLEDGMENT OF COMPLETED SERVICES**

Dear Sir,

We are pleased to inform you that we have successfully completed the consultancy services for 03MW Solar Project at unit AGI Denim Unit-2, Shah Latif Town, Karachi.

The scope of services has been executed in full compliance with the agreed terms and timelines. We kindly request your acknowledgment of the completion of these services.

Should you require any further clarifications or documentation, please feel free to contact us.

Sincerely,

**M/s A.E.A International (Pvt.) Ltd.**

**Name: Suhaib-Ul-Mukhtar**

**Designation: C.E.O**

**Signature:**

**M/s Artistic Garment Industries**  
**(AGI Denim) (Pvt.) Ltd.**

**Name: Mr. Shahab Ahmed**

**Designation: Project Head**

**Signature:**

**PROJECT COMPLETION CERTIFICATE FOR**  
**03-MW SOLAR CONSULTANCY**

**To Whom It May Concern**

This letter formally recognizes and appreciates the excellent consultancy services provided by M/s. A.E.A. International (Pvt.) Ltd. for the successful completion of the 03-MW Solar Project at our AGI Denim Unit 02, at Shah Latif Town, Karachi.

We are pleased to confirm that the system is performing as expected, delivering energy outputs in line with projections. This achievement is a testament to the exceptional standards, technical proficiency, and professionalism demonstrated by your organization.

Regards,



Shahab Ahmed  
Project Head



M/s. Artistic Garment Industries  
(AGI Denim) (Pvt.) Ltd.



• Genset Synchronization  
• PV Diesel Control Solutions  
• Onsite/In-house Training Services  
• Solar Structure & Installation  
• Automation & Control Systems  
• Power & Control Panels

**Dated: 17<sup>th</sup> October, 2022**

M/s A.E.A International (Pvt.) Ltd.  
Suite # 313, 3rd Floor, Anum Estate,  
Shahrah-e-Faisal-Karachi  
Pakistan.

**Subject: Award of Consultancy Services for 4 MW Solar Project at our AJ Textile, Swabi**

Dear Sir,

After a careful evaluation of the proposal submitted for the consultancy services related to our upcoming solar project, the management has found that your proposal demonstrated a comprehensive understanding of the project requirements, as well as the expertise and experience necessary to ensure its successful execution. Therefore, we are pleased to inform you that your firm has been selected as consultant for our upcoming **4 MW Solar Project** to be installed at **AJ Textile, Swabi**. The mutually agreed consultancy fee is **PKR 0.9 per watt**, covering the following key services:

- Comprehensive Report on Site Assessment
- System Design and Engineering
- Vendor Evaluation
- Verification of approved material.
- Contractors Work Monitoring
- Periodic Work Progress Report

We expect that with your expertise in the field of renewable energy and the experience of your team, the project will be completed in the given timeline.

Please do not hesitate to contact us should you have any questions or require further information at this stage.

Sincerely,

Zubair Sultan  
Manager Sales & Operation  
Hub Engineering Pvt Ltd.



**Postal Address**

**Head Office**  
897-B, Faisal Town,  
Lahore-Pakistan.  
Tel: +92 42 35218643

**Karachi Office:**  
C/174 Block 9,  
Gulshan-E-Iqbal, Karachi.  
Tel: +92 332 360 0856



**A.E.A INTERNATIONAL (PVT.) LIMITED**  
**PLANNERS & CONSULTING ENGINEERS**

M/s Hub Engineering (Pvt.) Ltd.  
897B, Faisal Town,  
Lahore,  
Pakistan.

Dated: 18<sup>th</sup> July, 2023

Subject: Request for Acknowledgment of Completed Services

Dear Sir,

We are pleased to inform you that we have successfully completed the consultancy services as outlined in Purchase Order # PO-22-0002 for the 4 MW Solar Project at AJ Textile, Swabi.

The scope of services has been executed in full compliance with the agreed terms and timelines. We kindly request your acknowledgment of the completion of these services.

Should you require any further clarifications or documentation, please feel free to contact us.

Sincerely,

M/s A.E.A International (Pvt.) Ltd.

Name: Mr. Suhaib-UI-Mukhtar



Designation: C.E.O.

Signature: 

Date: 18-07-2023

M/s Hub Engineering (Pvt.) Ltd.

Name: Zubair Sultan

Designation: Manager Operations

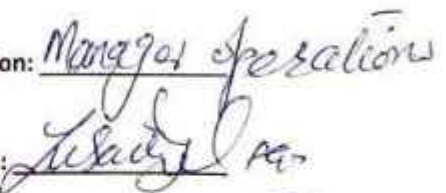
Signature: 

Date: 21/07/23





- Genset Synchronization
- PV Diesel Control Solutions
- Onsite/In-house Training Services
- Solar Structure & Installation
- Automation & Control Systems
- Power & Control Panels

# CERTIFICATE OF COMPLETION

## To Whom It May Concern

This is to formally acknowledge and appreciate the outstanding consultancy services provided by **M/s A.E.A International (Pvt.) Ltd.** for the successful completion of the **4 MW Solar Project at AJ Textile, Swabi.**

We are pleased to confirm that the system is performing optimally, delivering energy outputs as projected. This achievement reflects the exceptional best practices, technical expertise, and professionalism demonstrated by your team throughout the project.

Your dedication to quality and meticulous attention to detail have been instrumental in ensuring the success of this project. We commend your efforts and look forward to future collaborations.

Issued by:

Zubair Sultan  
Manager Sales & Operation  
M/s Hub Engineering Pvt Ltd



### Postal Address

#### Head Office

897-B, Faisal Town,  
Lahore-Pakistan.  
Tel: +92 42 35218643

#### Karachi Office:

C/174 Block 9,  
Gulshan-E-Iqbal, Karachi.  
Tel: +92 332 360 0856



info@hubengineering.pk

www.hubengineering.pk



- Genset Synchronization
- PV Diesel Control Solutions
- Onsite/In-house Training Services
- Solar Structure & Installation
- Automation & Control Systems
- Power & Control Panels

**Dated: 16<sup>th</sup> January, 2023**

M/s A.E.A International (Pvt.) Ltd.  
Suite # 313, 3rd Floor, Anum Estate,  
Shahrah-e-Faisal-Karachi  
Pakistan.

**Subject: Award of Consultancy Services for 03MW Solar Project at our (Umer Spinning Mill USM)**

Dear Sir,

After a careful evaluation of the proposal submitted for the consultancy services related to our upcoming solar project, the management has found that your proposal demonstrated a comprehensive understanding of the project requirements, as well as the expertise and experience necessary to ensure its successful execution. Therefore, we are pleased to inform you that your firm has been selected as consultant for our upcoming **03MW Solar Project** to be installed at **Umer Spinning Mill**. The mutually agreed consultancy fee is **PKR 1 per watt** covering the following key services:

- Comprehensive Report on Site Assessment
- System Design and Engineering
- Vendor Evaluation
- Verification of approved material.
- Contractors Work Monitoring
- Periodic Work Progress Report

We expect that with your expertise in the field of renewable energy and the experience of your team, the project will be completed in the given timeline.

Please do not hesitate to contact us should you have any questions or require further information at this stage.

Sincerely,

**Zubair Sultan**  
**Manager Sales & Operation**  
**Hub Engineering Pvt Ltd.**



**Postal Address**

**Head Office**  
897-B, Faisal Town,  
Lahore-Pakistan,  
Tel: +92 42 35218643

**Karachi Office:**  
C/174 Block 9,  
Gulshan-E-Iqbal, Karachi.  
Tel: +92 332 360 0856



**A.E.A INTERNATIONAL (PVT.) LIMITED**  
**PLANNERS & CONSULTING ENGINEERS**

M/s Hub Engineering (Pvt.) Ltd.  
897B, Faisal Town,  
Lahore,  
Pakistan.

Dated: 28<sup>th</sup> July, 2023

Subject: Request for Acknowledgment of Completed Services

Dear Sir,

We are pleased to inform you that we have successfully completed the consultancy services as outlined in Purchase Order # PO-22-0001 for the 3 MW Solar Project at Umer Spinning Mills, Lahore.

The scope of services has been executed in full compliance with the agreed terms and timelines. We kindly request your acknowledgment of the completion of these services.

Should you require any further clarifications or documentation, please feel free to contact us.

Sincerely,

M/s A.E.A International (Pvt.) Ltd.

Name: Mr. Rakhshan Ali Khan

Designation: Chairman

Signature: [Handwritten Signature]

Date: 28-07-2023



M/s Hub Engineering (Pvt.) Ltd.

Name: Zubair Sultan

Designation: Manager Operations

Signature: [Handwritten Signature]

Date: 31/07/24





Power Control  
Automation Company

- Genset Synchronization
- PV Diesel Control Solutions
- Onsite/In-house Training Services
- Solar Structure & Installation
- Automation & Control Systems
- Power & Control Panels

# CERTIFICATE OF COMPLETION

## To Whom It May Concern

This is to formally acknowledge and appreciate the outstanding consultancy services provided by M/s **A.E.A International (Pvt.) Ltd.** for the successful completion of the **3 MW Solar Project at Umar Spinning Mills, Lahore.**

We are pleased to confirm that the system is performing optimally, delivering energy outputs as projected. This achievement reflects the exceptional best practices, technical expertise, and professionalism demonstrated by your team throughout the project.

Your dedication to quality and meticulous attention to detail have been instrumental in ensuring the success of this project. We commend your efforts and look forward to future collaborations.

Issued by:

Zubair Sultan  
Manager Sales & Operation  
M/s Hub Engineering Pvt Ltd



### Postal Address

**Head Office**  
897-B, Faisal Town,  
Lahore-Pakistan.  
Tel: +92 42 35218643

**Karachi Office:**  
C/174 Block 9,  
Gulshan-E-Iqbal, Karachi.  
Tel: +92 332 360 0856

# Artistic Fabric Mills Pvt. Ltd.

Dated: 29-06-2020

M/s. A.E.A. International (Pvt.) Ltd.  
Suite # 313, 3rd Floor,  
Anum Estate, Shahrah-e-Faisal,  
Karachi- Pakistan.

Subject: **AWARD OF CONSULTANCY SERVICES FOR 1.0-MW SOLAR PROJECT AT UNIT AFM-1**

Dear Sir,

We are pleased to inform you that our management has found your Consultancy Proposal workable and up to the mark. We, therefore have decided to award you the Consultancy job for 1.0 MW Solar Project for our AFM- Unit-1, located at Manzil Pump Landhi, Bin Qasim Town.

We hope that your expertise in this field will cover all the aspects of the services mentioned below:

- Site Assessment for Panels Structure
- System Design and Engineering
- Verification of approved material.
- Monitoring of Contractors Work
- Periodic Work Progress Report

We expect that you will complete the whole job according to given time frame.

Thanking you,

For Artistic Fabric Mills (Pvt.) Ltd.



**Ghulam Ghous Amjad**  
C.O.O

**Corporate Office:**  
Artistic Tower  
39 A Block 6, P.E.C.H.S,  
Karachi, Pakistan-75400  
+9221 111-004-004

GST: 3277876189540  
NTN: 5370878-2  
[www.artisticfabricmills.com](http://www.artisticfabricmills.com)  
[www.instagram.com/afmdenim](https://www.instagram.com/afmdenim)  
[inquiry@artisticfabricmills.com](mailto:inquiry@artisticfabricmills.com)

**Spinning Division:**  
Plot No 14 Survey 16 & 17 Shah Latif  
Town, National Highway Karachi  
Pakistan, +9221-34100271-5

**Fabric Division:**  
472 Deh Landhi Bin Qasim  
Town, Karachi, Pakistan-75120  
+9221-35023594-5

**Garment Division:**  
Plot 7 Sector 21, Korangi Industrial Area,  
Karachi, Pakistan-74900



**ARTISTIC FABRIC MILLS**

# Artistic Fabric Mills Pvt. Ltd.

Date: 25-July-2021

## 1.0 MW SOLAR PROJECT COMPLETION CERTIFICATE

### TO WHOM IT MAY CONCERN

This letter formally recognizes and appreciates the excellent consultancy services provided by M/s A.E.A. International (Pvt.) Ltd. for the successful completion of the 1.0 MW Solar Project at our AFM-1 Unit- Manzil Pump Landhi, Bin Qasim Town, Karachi.

We are pleased to confirm that the system is performing as expected, delivering energy outputs in line with projections. This achievement is a testament to the exceptional standards, technical proficiency, and professionalism demonstrated by your organization.

Issued by:

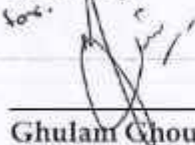

Ghulam Ghous Amjad  
C.O.O

ARTISTIC FABRIC MILLS (PVT.) LTD.

**Corporate Office:**

Artistic Tower  
39 A Block 6, P.E.C.H.S,  
Karachi, Pakistan-75400  
+9221 111-004-004

GST: 3277876189540  
NTN: 5370878-2

www.artisticfabricmills.com  
www.instagram.com/afmdenim  
inquiry@artisticfabricmills.com

**Spinning Division:**

Plot No 14 Survey 16 & 17 Shah Latif  
Town, National Highway Karachi  
Pakistan, +9221-34100271-5

**Fabric Division:**

472 Deh Landhi Bin Qasim  
Town, Karachi, Pakistan-75120  
+9221-35023594-5

**Garment Division:**

Plot 7 Sector 21, Korangi Industrial Area,  
Karachi, Pakistan-74900



ARTISTIC FABRIC MILLS

# Artistic Fabric Mills Pvt. Ltd.

Dated: 29-06-2020

**M/s. A.E.A. International (Pvt.) Ltd.**  
Suite # 313, 3rd Floor, Anum Estate,  
Shahrah-e-Faisal, Karachi- Pakistan.

Subject: **AWARD OF CONSULTANCY SERVICES FOR 1.2-MW SOLAR PROJECT  
AT UNIT AFM-4**

Dear Sir,

We are pleased to inform you that our management has found your Consultancy Proposal workable and up to the mark. We, therefore have decided to award you the Consultancy job for 1.2 MW Solar Project for our AFM-Unit-4, located at Korangi Industrial Area, Korangi- Karachi

We hope that your expertise in this field will cover all the aspects of the services mentioned below.

The consultancy services will cover the following key areas:

- Site Assessment for Panels Structure
- System Design and Engineering
- Verification of approved material.
- Monitoring of Contractors Work
- Periodic Work Progress Report

We expect that you will complete the whole job according to given time frame.

Thanking you,

For Artistic Fabric Mills (Pvt.) Ltd.



**Ghulam Ghous Amjad**  
C.O.O

**Corporate Offices:**

Artistic Tower  
39 A Block G, P.E.C.H.S,  
Karachi, Pakistan-75400  
+9221 111-004-004

QST: 3277676189540

NTN: 5270878-2

www.artisticfabricmills.com  
www.instagram.com/afmdenim  
inquiry@artisticfabricmills.com

**Spinning Division:**

Plot No 14 Survey 16 & 17 Shah Latif  
Town, National Highway Karachi  
Pakistan, +9221-34100271-5

**Fabric Division:**

472 Deh Landhi Bin Qasim  
Town, Karachi, Pakistan-75120  
+9221-35023594-5

**Garment Division:**

Plot 7 Sector 21, Korangi Industrial Area,  
Karachi, Pakistan-74900



**ARTISTIC FABRIC MILLS**

# Artistic Fabric Mills Pvt. Ltd.

Date: 10-Aug-2021

## 1.2 MW SOLAR PROJECT COMPLETION CERTIFICATE

### TO WHOM IT MAY CONCERN

This letter formally recognizes and appreciates the excellent consultancy services provided by M/s A.E.A. International (Pvt.) Ltd. for the successful completion of the 1.2 MW Solar Project at our AFM-4 Unit- Korangi Industrial Area.

We are pleased to confirm that the system is performing as expected, delivering energy outputs in line with projections. This achievement is a testament to the exceptional standards, technical proficiency, and professionalism demonstrated by your organization.

Issued by:



**Ghulam Ghous Amjad**  
C.O.O

**ARTISTIC FABRIC MILLS (PVT.) LTD.**

**Corporate Office:**

Artistic Tower  
39 A Block 6, P.E.C.H.S,  
Karachi, Pakistan-75400  
+9221 111-004-004

GST: 3277876189540

NTN: 5370878-2

[www.artisticfabricmills.com](http://www.artisticfabricmills.com)  
[www.instagram.com/afm4denim](http://www.instagram.com/afm4denim)  
[inquiry@artisticfabricmills.com](mailto:inquiry@artisticfabricmills.com)

**Spinning Division:**

Plot No 14 Survey 16 & 17 Shah Latif  
Town, National Highway Karachi  
Pakistan, +9221-34100271-5

**Fabric Division:**

472 Deh Landhi Bin Qasim  
Town, Karachi, Pakistan-75120  
+9221-35023594-5

**Garment Division:**

Plot 7 Sector 21, Korangi Industrial Area,  
Karachi, Pakistan-74300



**ARTISTIC FABRIC MILLS**

# Artistic Fabric Mills Pvt. Ltd.

Dated: 29-06-2020

**M/S. A.E.A. INTERNATIONAL (PVT.) LTD.**  
Suite # 313, 3rd Floor, Anum Estate,  
Shahrah-e-Faisal, Karachi- Pakistan.

Subject: **AWARD OF CONSULTANCY SERVICES FOR 2.5-MW SOLAR PROJECT AT UNIT AFM-7**

Dear Sir,

We are pleased to inform you that our management has found your Consultancy Proposal workable and up to the mark. We, therefore have decided to award you the Consultancy job for 2.5 MW Solar Project for our AFM- Unit-7, located at Shah Latif Town.

We hope that your expertise in this field will cover all the aspects of the services mentioned below:

- Site Assessment for Panels Structure
- System Design and Engineering
- Verification of approved material.
- Monitoring of Contractors Work
- Periodic Work Progress Report

We expect that you will complete the whole job according to given time frame.

Thanking you,

For Artistic Fabric Mills (Pvt.) Ltd.

  
\_\_\_\_\_  
**Ghulam Ghaus Amjad**  
C.O.O

**Corporate Offices:**

Artistic Tower  
39 A Block 6, P.E.C.H.S,  
Karachi, Pakistan-75400  
+9221 111-004-004

QST: 3277876189540  
NTN: 5370878-2

[www.artisticfabricmills.com](http://www.artisticfabricmills.com)  
[www.instagram.com/afmdenim](http://www.instagram.com/afmdenim)  
[inquiry@artisticfabricmills.com](mailto:inquiry@artisticfabricmills.com)

**Spinning Division:**

Plot No 14 Survey 16 & 17 Shah Latif  
Town, National Highway Karachi  
Pakistan, +9221-34100271-5

**Fabric Division:**

472 Deh Landhi Bin Qasim  
Town, Karachi, Pakistan-75120  
+9221-35023594-5

**Garment Division:**

Plot 7 Sector 21, Korangi Industrial Area,  
Karachi, Pakistan-74900



**ARTISTIC FABRIC MILLS**

# Artistic Fabric Mills Pvt. Ltd.

Date: 04-Nov-2024

## PROJECT COMPLETION CERTIFICATE 2.5 MW SOLAR CONSULTANCY

### To Whom It May Concern

This letter formally recognizes and appreciates the excellent consultancy services provided by M/s A.E.A. International (Pvt.) Ltd. for the successful completion of the 2.5 MW Solar Project at our AFM-7 Unit- located in Shah Latif Town.

We are pleased to confirm that the system is performing as expected, delivering energy outputs in line with projections. This achievement is a testament to the exceptional standards, technical proficiency, and professionalism demonstrated by your organization.

Issued by:



Ghulam Ghous Amjad  
C.O.O

ARTISTIC FABRIC MILLS (PVT.) LTD.

**Corporate Office:**

Artistic Tower  
39 A Block 5, P.E.C.H.S.  
Karachi, Pakistan-75400  
+9221 111-004-004

GST: 3277876189540

NTN: 5370878-2

[www.artisticfabricmills.com](http://www.artisticfabricmills.com)

[www.instagram.com/afmdenlm](https://www.instagram.com/afmdenlm)

[inquiry@artisticfabricmills.com](mailto:inquiry@artisticfabricmills.com)

**Spinning Division:**

Plot No 14 Survey 16 & 17 Shah Latif  
Town, National Highway Karachi  
Pakistan, +9221-34100271-5

**Fabric Division:**

472 Deh Landhi Bin Qasim  
Town, Karachi, Pakistan-75120  
+9221-35023594-5

**Garment Division:**

Plot 7 Sector 21, Korangi Industrial Area,  
Karachi, Pakistan-74900



ARTISTIC FABRIC MILLS



**COMPANY CERTIFICATE FOR NO  
LITIGATION**



**A.E.A INTERNATIONAL (PVT.) LIMITED**  
**PLANNERS & CONSULTING ENGINEERS**

Ref No. AEAI/01/2023#01010

January 18, 2023

**TO WHOM IT MAY CONCERN**

We hereby certify that our firm "A.E.A International (Private) Limited" is not being black listed and not declared defaulter by any Public or Private Agency / Department / Institution in any case. We certify that all the given information is true and best of our knowledge.

Sincerely,

For: **A.E.A International (Private) Limited.**

**Fouzia Rehman**  
(Admin Officer)



## REFERENCE DRAWINGS

REFERENCE ONLY

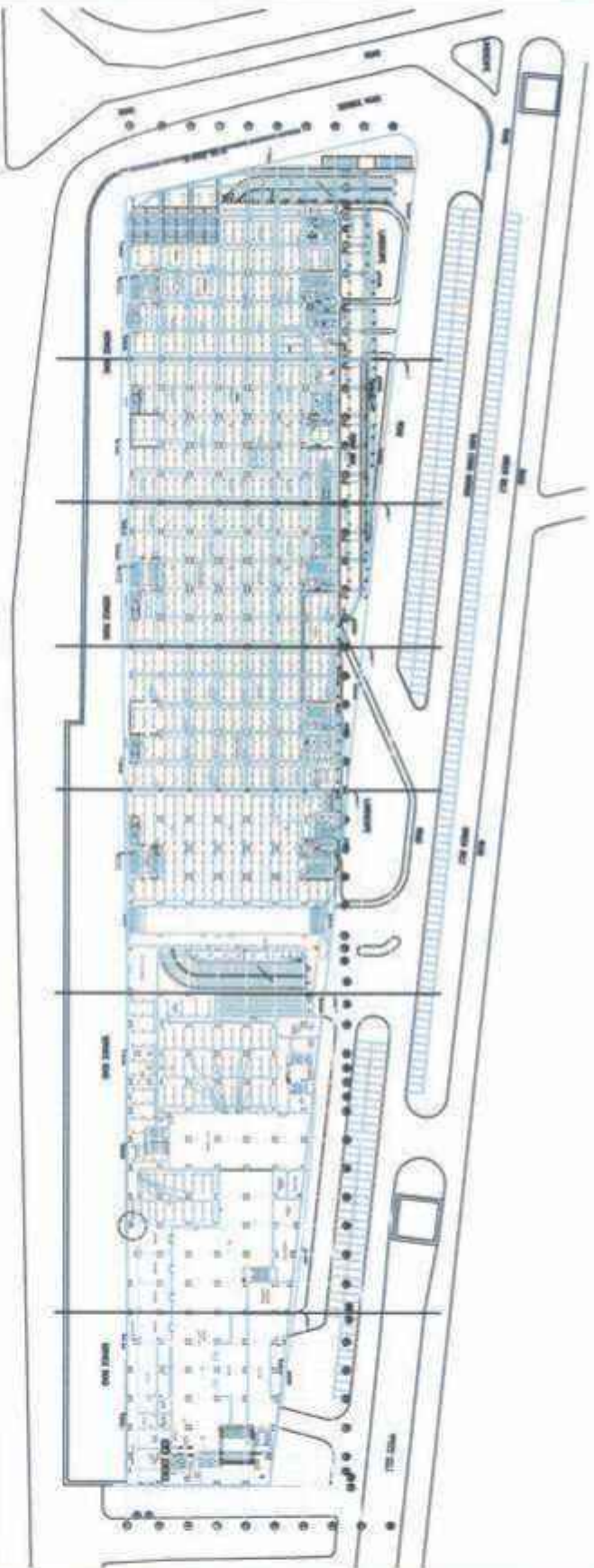

LOWER GROUND FLOOR

LEGEND

1	Column
2	Beam
3	Wall
4	Door
5	Window
6	Stair
7	Elevator
8	Escalator
9	Service Area
10	Room
11	Corridor
12	Other



Notes: 1. All dimensions are in meters.  
2. All dimensions are to the centerline of the structure.  
3. All dimensions are to the centerline of the structure.  
4. All dimensions are to the centerline of the structure.

No.	Description	Quantity	Unit	Remarks
1	Column			
2	Beam			
3	Wall			
4	Door			
5	Window			
6	Stair			
7	Elevator			
8	Escalator			
9	Service Area			
10	Room			
11	Corridor			
12	Other			

DATE: 15/08/2010  
 DRAWN BY: [Name]  
 CHECKED BY: [Name]  
 APPROVED BY: [Name]

**PT. PRIMA ENGINEERING**  
**ADVANCED ENGINEERING ASSOCIATES**  
 JAWA BARU  
 JALAN [Address]  
 SURABAYA

**PT. PRIMA ENGINEERING**  
**ADVANCED ENGINEERING ASSOCIATES**  
 JAWA BARU  
 JALAN [Address]  
 SURABAYA

**PT. PRIMA ENGINEERING**  
**ADVANCED ENGINEERING ASSOCIATES**  
 JAWA BARU  
 JALAN [Address]  
 SURABAYA

**PT. PRIMA ENGINEERING**  
**ADVANCED ENGINEERING ASSOCIATES**  
 JAWA BARU  
 JALAN [Address]  
 SURABAYA

REFERENCE ONLY

31-12-2018

31-12-2018

31-12-2018

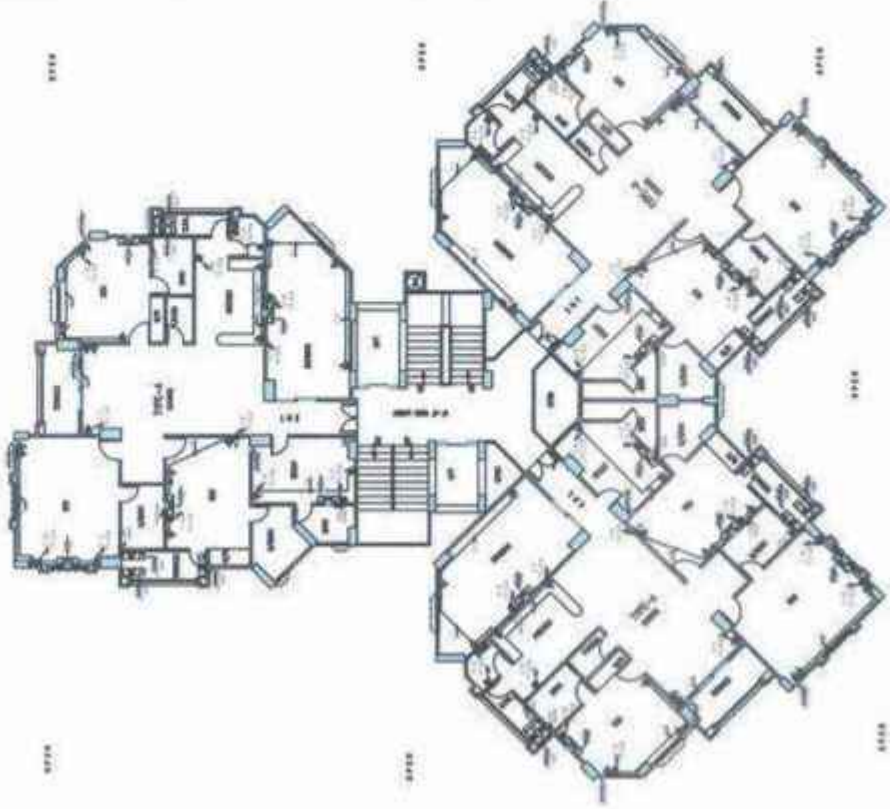

LIGHTING PLAN

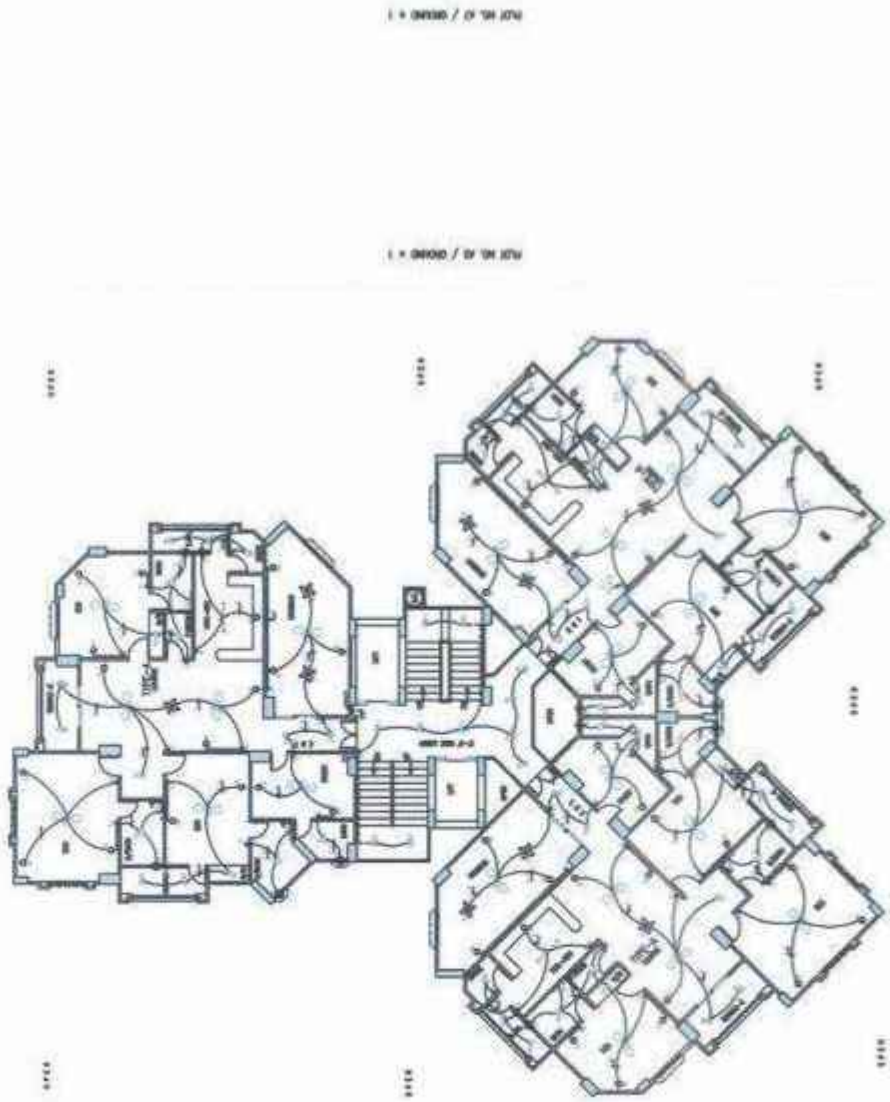

POWER PLAN

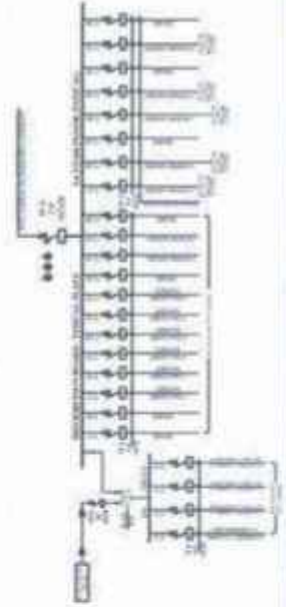

REF NO. 12 / 00000

REF NO. 12 / 00000

REF NO. 12 / 00000

REF NO. 12 / 00000

 ADVISORS & ENGINEERS	RIAZ BHAI BATHISLAND KARACHI	 MUSCADA CONSULTING ADVISORS & ENGINEERS	ADVANCE ENGINEERING ASSOCIATES ADVISORS & ENGINEERS	ELECTRICAL WORKS	1ST TO 8TH TYPICAL FLOOR LIGHTING & POWER PLAN (PROPOSED)	PROJECT NO. / DATE SHEET NO. / TOTAL SHEETS CLIENT / CONTRACT NO. / DATE DESIGNER / DATE CHECKER / DATE APPROVED BY / DATE PREPARED BY / DATE
	This plan represents all items having a bearing on the structure.					

# REFERENCE ONLY

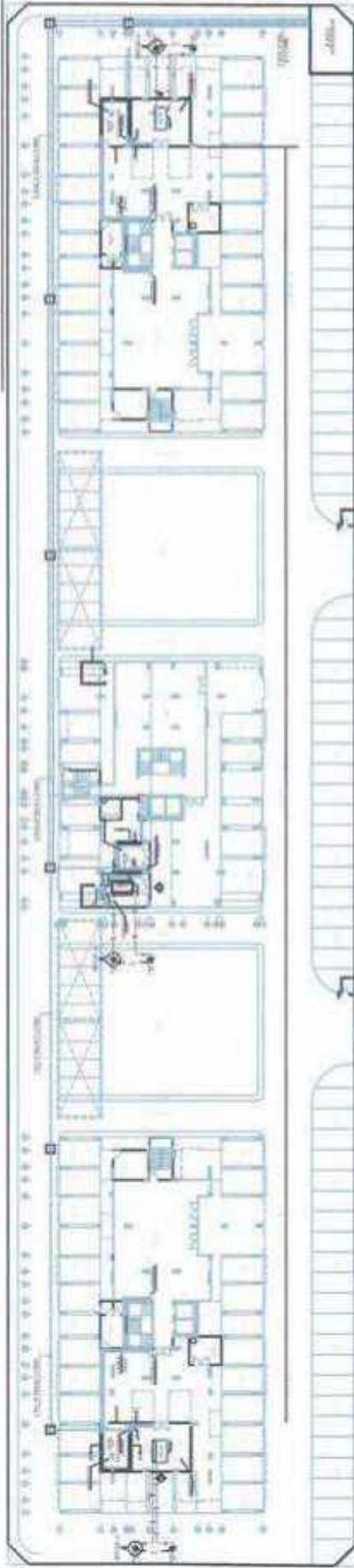

SCALE: 1/4"=1'-0"



SCALE: 3/16"=1'-0"

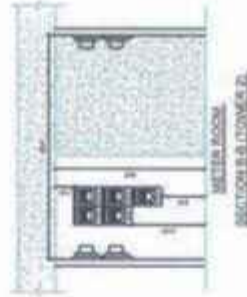

SCALE: 1/4"=1'-0"



SCALE: 3/16"=1'-0"



Scale: 1/4"=1'-0"  
 Project: SERENA TERRACE  
 Drawing: ELECTRICAL

	ADVANCE ENGINEERING ASSOCIATES, INC. 10000 W. 16th Ave., Suite 100 Denver, CO 80202 Phone: (303) 751-1111 Fax: (303) 751-1112 www.advanceeng.com	PROJECT NO. 10000 W. 16th Ave.	SHEET NO. 10000 W. 16th Ave.	DATE 10/20/10	DRAWN BY J. [Name]	CHECKED BY [Name]	DESIGNED BY [Name]	APPROVED BY [Name]	TITLE ELECTRICAL	PROJECT NO. 10000 W. 16th Ave.	SHEET NO. 10000 W. 16th Ave.	DATE 10/20/10	DRAWN BY J. [Name]	CHECKED BY [Name]	DESIGNED BY [Name]	APPROVED BY [Name]	TITLE ELECTRICAL
	SERENA TERRACE ADVANCE ENGINEERING ASSOCIATES, INC.																



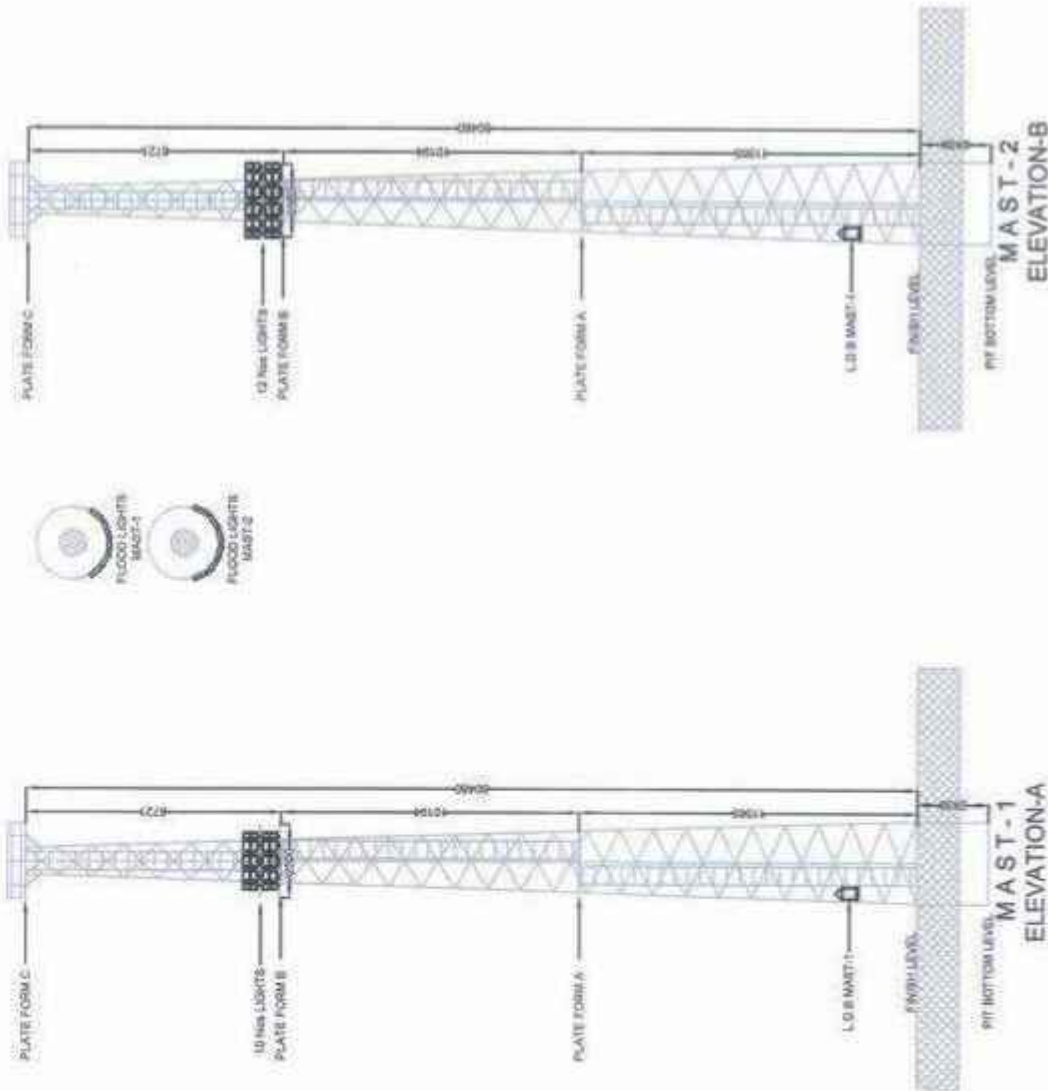

### LUMINAIRE LAYOUT

LS-CERT NO	TYPE	X (M)	Y (M)	H (M)	Z (F)	T (F)
01	1	8.00	990.00	19.80	-155.83	45.00
02	1	8.00	100.25	19.80	-170.84	60.00
03	1	8.00	000.48	19.80	-179.84	75.00
04	1	8.00	102.48	19.80	-192.38	75.00
05	1	8.00	000.00	19.80	-193.08	75.00
06	1	8.00	100.00	19.80	-198.53	75.00
07	1	8.00	000.00	19.80	-198.90	75.00
08	1	8.00	000.00	19.80	-198.90	75.00
09	1	8.00	100.00	19.80	-192.69	74.96
10	1	8.00	000.00	19.80	-82.05	75.00
11	1	75.00	25.00	19.80	4.26	70.00
12	1	75.00	23.00	19.80	-2.13	70.00
13	1	75.00	25.00	19.80	-15.08	70.00
14	1	75.00	23.00	19.80	-24.22	70.00
15	1	75.00	23.00	19.80	-47.83	70.00
16	1	75.00	23.00	19.80	-43.99	70.00
17	1	75.00	23.00	19.80	-48.09	70.00
18	1	75.00	23.00	19.80	-77.40	70.00
19	1	75.00	23.00	19.80	-67.91	70.00
20	1	75.00	23.00	19.80	-64.83	70.00
21	1	75.00	23.00	19.80	-100.26	70.00
22	1	75.00	23.00	19.80	-115.00	70.00

### CONCEPTUAL DRAWING

 <b>ADVANCE ENGINEERING ASSOCIATES</b> <small>REGISTERED ELECTRICAL ENGINEERS</small> <small>101, WILSON ROAD, #10-01, SINGAPORE 121228</small>	<b>ELECTRIFICATION WORK FOR S.D.O PARAGUAY BASE</b>	<b>MAST ELEVATIONS &amp; LUMINAIRE LAYOUT (PROPOSED)</b>	Scale: 1:10 Date: 11/18	Drawn: [Name] Checked: [Name]	No. of Sheets: 10 Sheet No.: 001	Project No.: [Number] Drawing No.: [Number]
			This project requires the use of patent bearing & luminaire trademarks.			



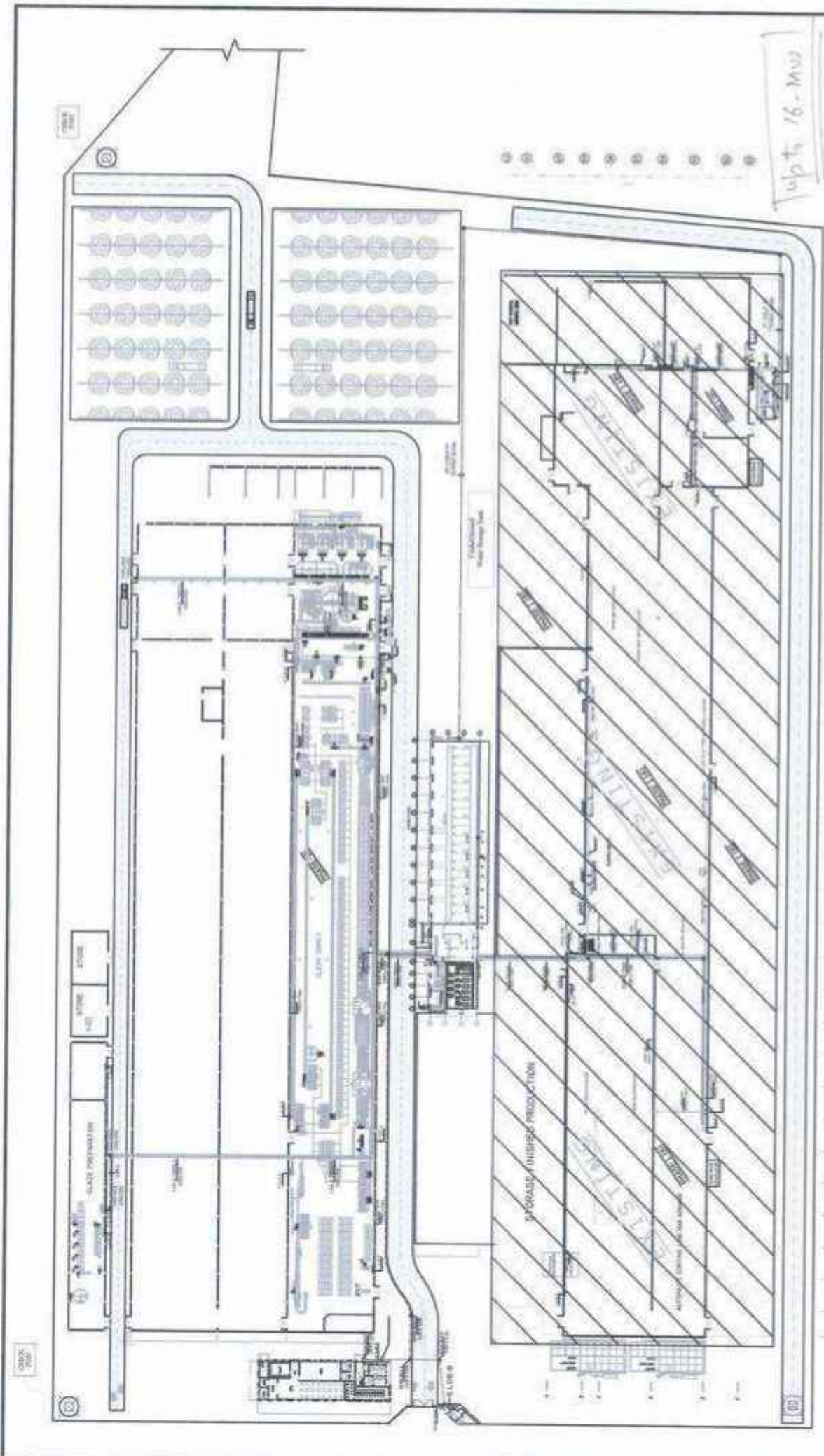

up to 16-MV

CONTRACT DRAWING

		<b>M/S SHABIB TILES &amp; CERAMICS LIMITED</b> 1071, AL-SAYEDAT AL-KHAYMA, AL-DIBBIYAH (RAJOURI) DISTRICT, AL-DIBBIYAH GOV. (TAX 45894)	<b>ADVANCE ENGINEERING ASSOCIATES</b> 107, AL-SAYEDAT AL-KHAYMA, AL-DIBBIYAH (RAJOURI) DISTRICT, AL-DIBBIYAH GOV. (TAX 45894)	<b>ELECTRICAL WORKS FOR WALL TILE</b>	<b>SITE PLAN WITH LOCATION OF POWER HOUSE, D.P.'S &amp; FEEDER ROUTES (PROPOSED)</b>	NO. 1706	DATE: 17/04/2018	SHEET NO. 02/04
						PROJECT NO. 1706	DRAWING NO. 02/04	CONTRACT NO. 1706

This plan is the property of the Engineer/Architect and is not to be used for any other purpose without his/her written consent.





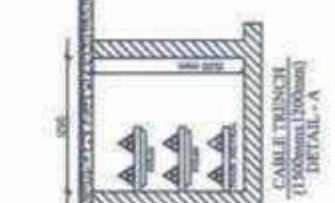
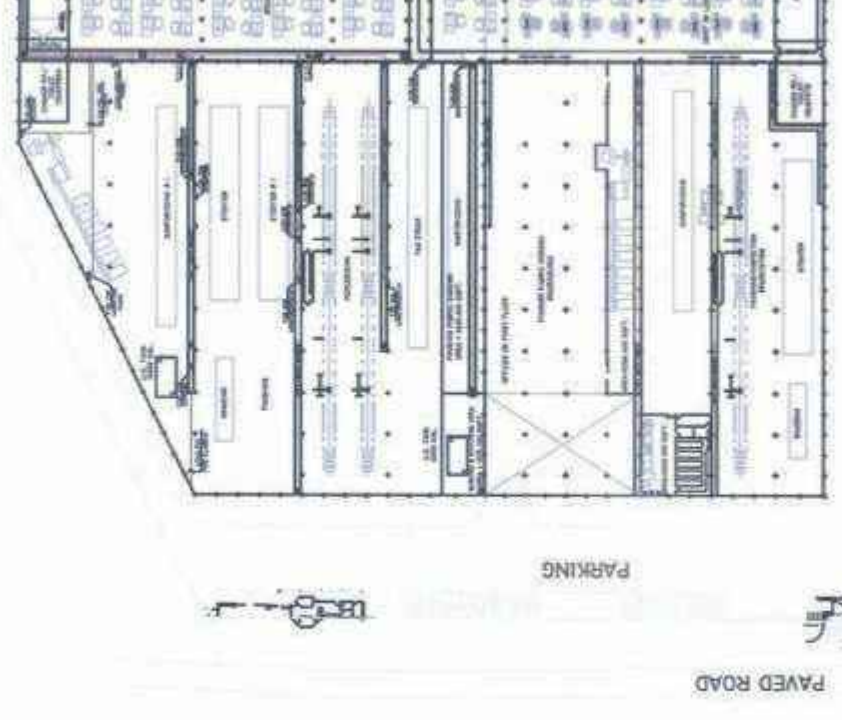
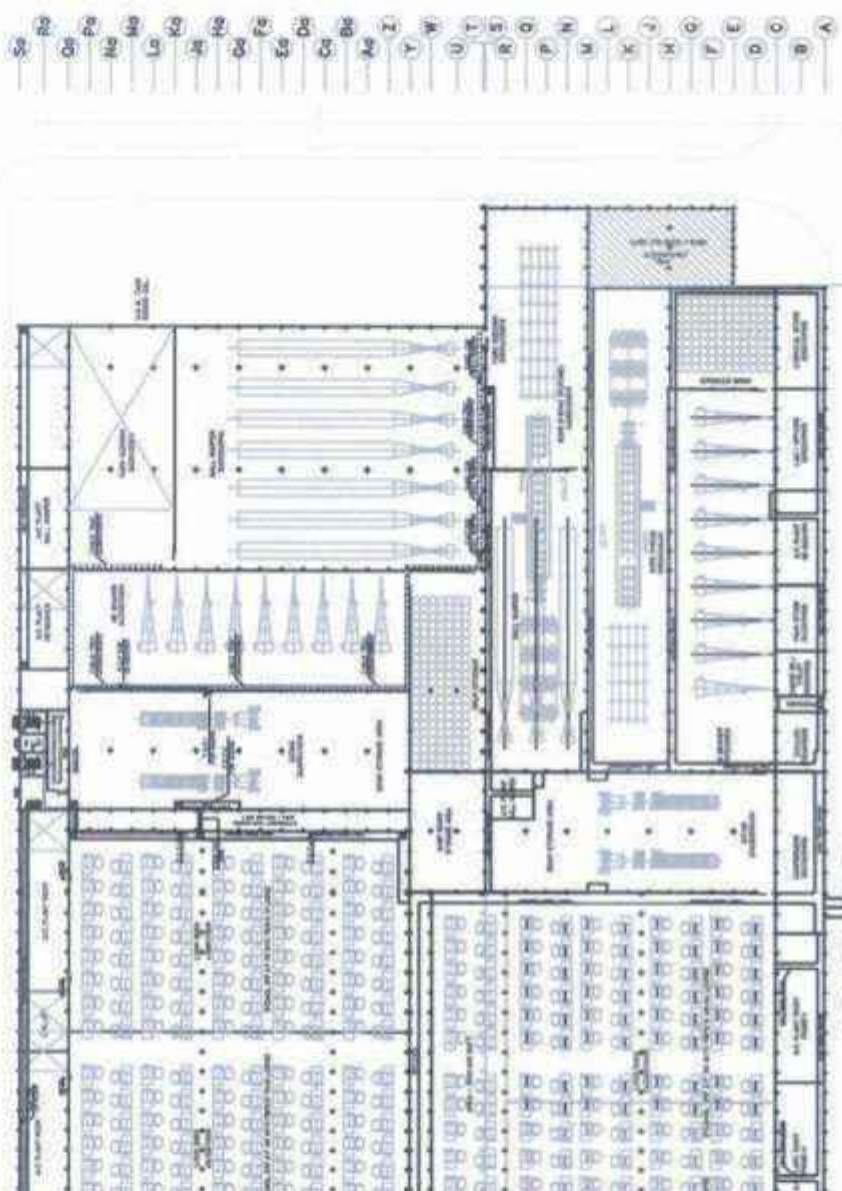

ISSUE FOR QUOTATION

NO.	DATE	DESCRIPTION
01	15/08/2024	ISSUE FOR QUOTATION
02	20/08/2024	REVISION 1: ADDITIONAL WORK
03	25/08/2024	REVISION 2: CORRECTED DIMENSIONS
04	30/08/2024	REVISION 3: FINAL APPROVAL

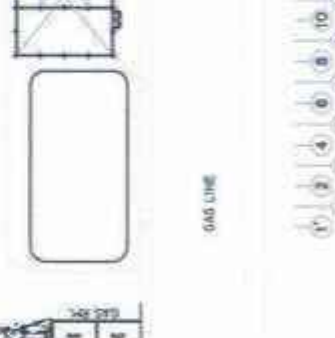
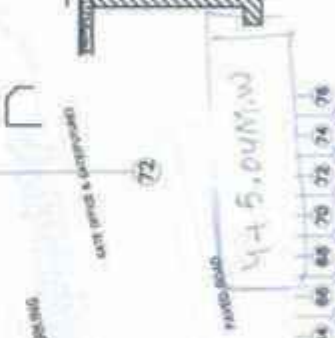

NO.	DATE	DESCRIPTION
01	15/08/2024	ISSUE FOR QUOTATION
02	20/08/2024	REVISION 1: ADDITIONAL WORK
03	25/08/2024	REVISION 2: CORRECTED DIMENSIONS
04	30/08/2024	REVISION 3: FINAL APPROVAL

THIS PRICE APPROXIMATES ALL PRICES BEARING A LOWER RISK THAN OTHER

ADVANCE ENGINEERING ASSOCIATES

SOORTY ENTERPRISES (LTD.)

SOORTY ENTERPRISES (LTD.)

V-15 M/07

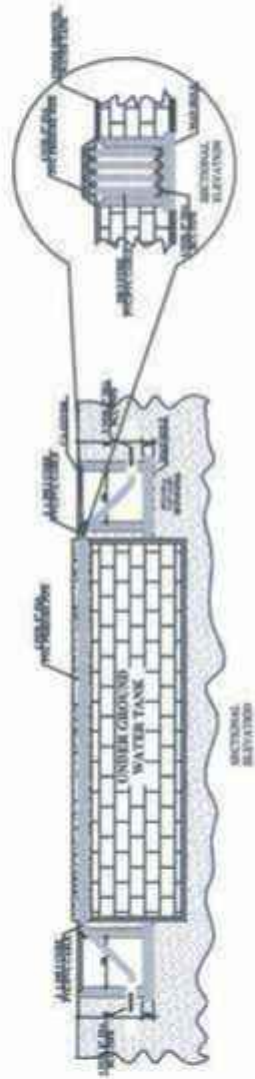
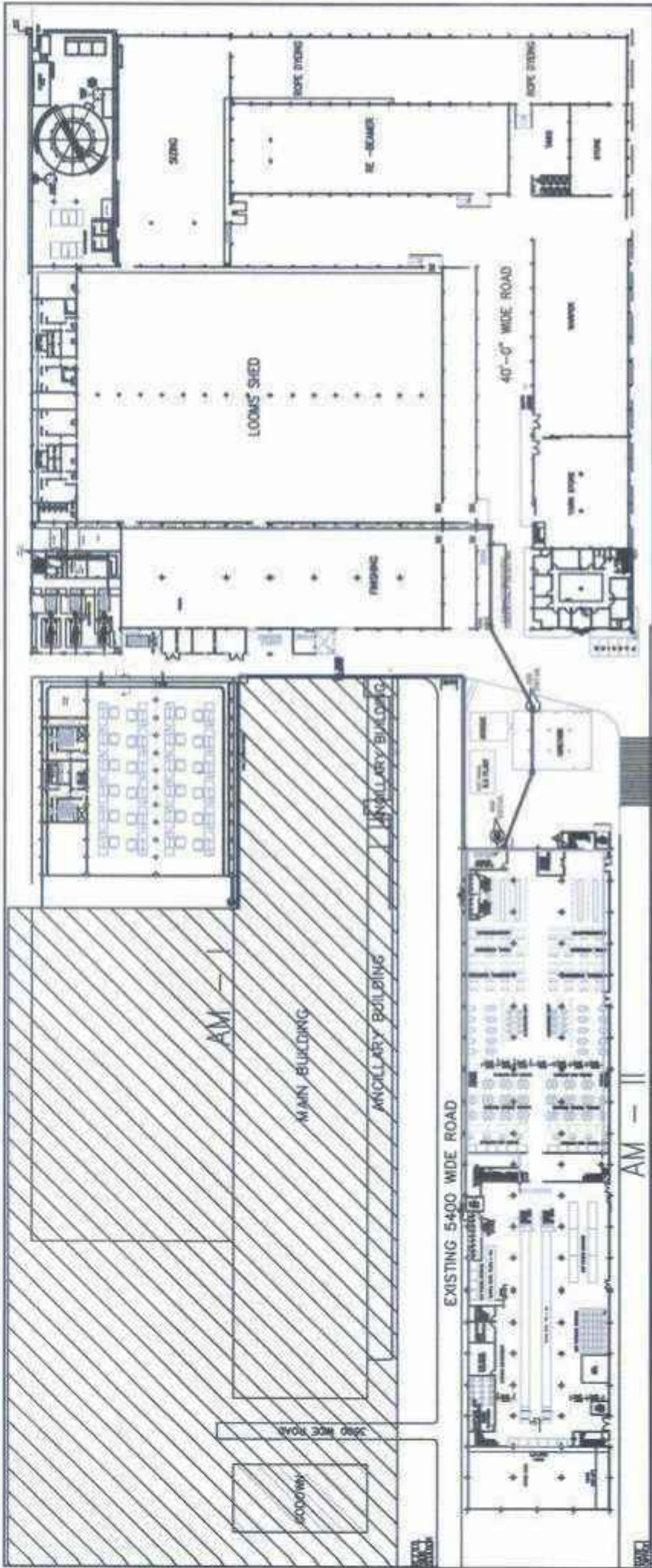

 ADVANCE ENGINEERING ASSOCIATES <small>ADVANCE ENGINEERING ASSOCIATES          105, HILL STREET, KARACHI - 75200</small>	CLIENT <b>Artistic Milliners Pvt Ltd,</b> GHAUSHTOWN, KARACHI PLOT NO. 4 & 5 SEC. 15 Kream Industrial Area Karachi	CONSULTANT <b>ADVANCE ENGINEERING ASSOCIATES</b> <small>ADVANCE ENGINEERING ASSOCIATES          105, HILL STREET, KARACHI - 75200</small>	PROJECT <b>ELECTRICAL WORKS FOR NEW GARMENT UNIT</b>	DRAWING NO. <b>V-15 M/07</b>	DATE <b>11/08/2007</b>	SCALE <b>AS SHOWN</b>	SHEET NO. <b>01 OF 01</b>	TOTAL SHEETS <b>01</b>	PROJECT NO. <b>AMG/04</b>
	SITE PLAN, WITH LOCATION OF NEW GARMENT UNIT. (PROPOSED)								
This plan represents all points having a level reference here									



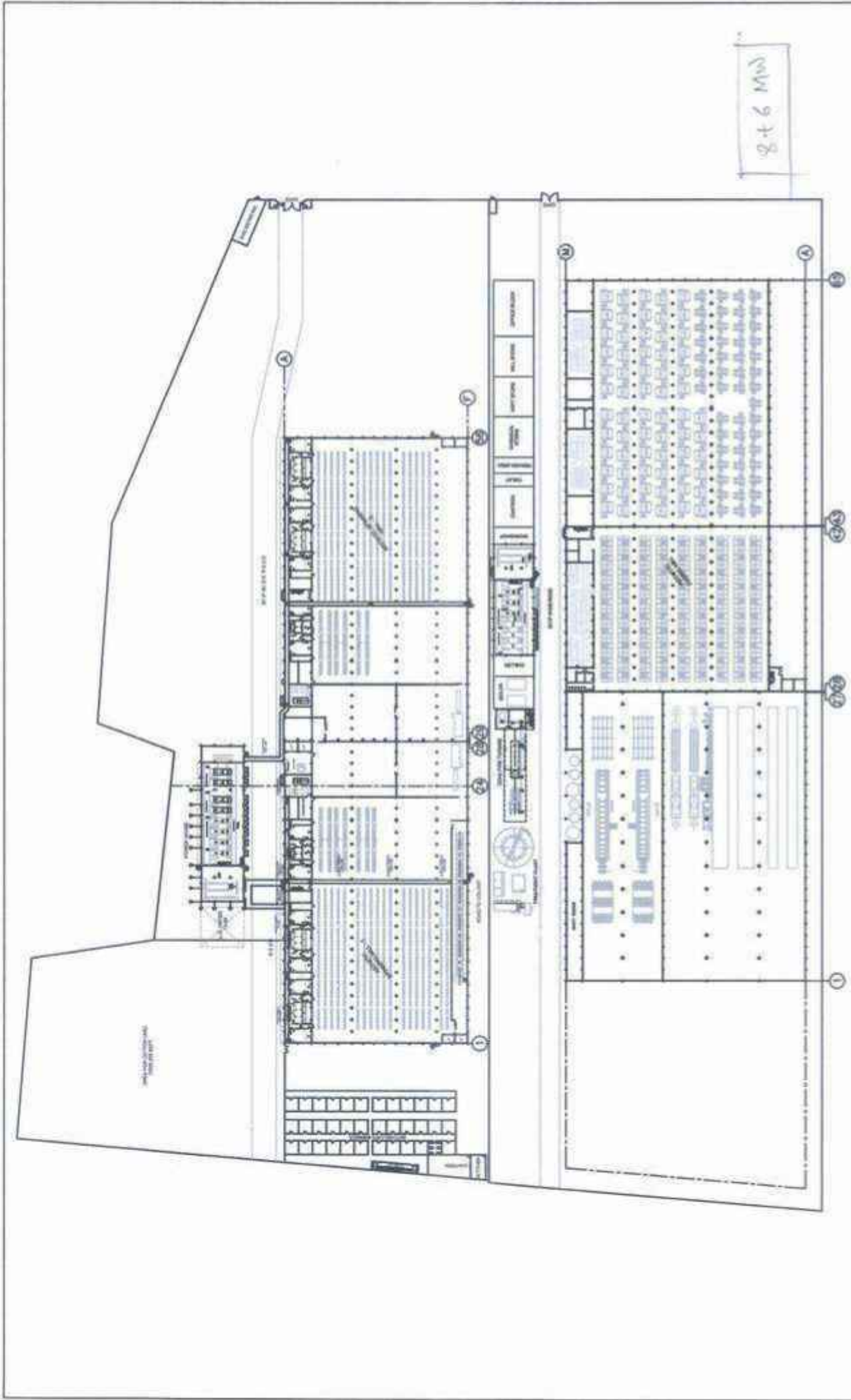

	<b>ARTISTIC FABRIC &amp; SPINNING MILLS,</b> BHASHI LAFI TOWN KARACHI	<b>ADVANCE ENGINEERING ASSOCIATES</b> <small>REGD. ELECTRICAL ENGINEERS</small> <small>REGD. ARCHITECTS</small>	<b>ELECTRICAL WORKS</b>	<b>SITE PLAN</b>
Scale: 1:1000 Date: 10/10/2023 Project No: 2023/010 Drawing No: 01				
This plan is the property of the client and is not to be used for any other purpose without the written consent of the client.				



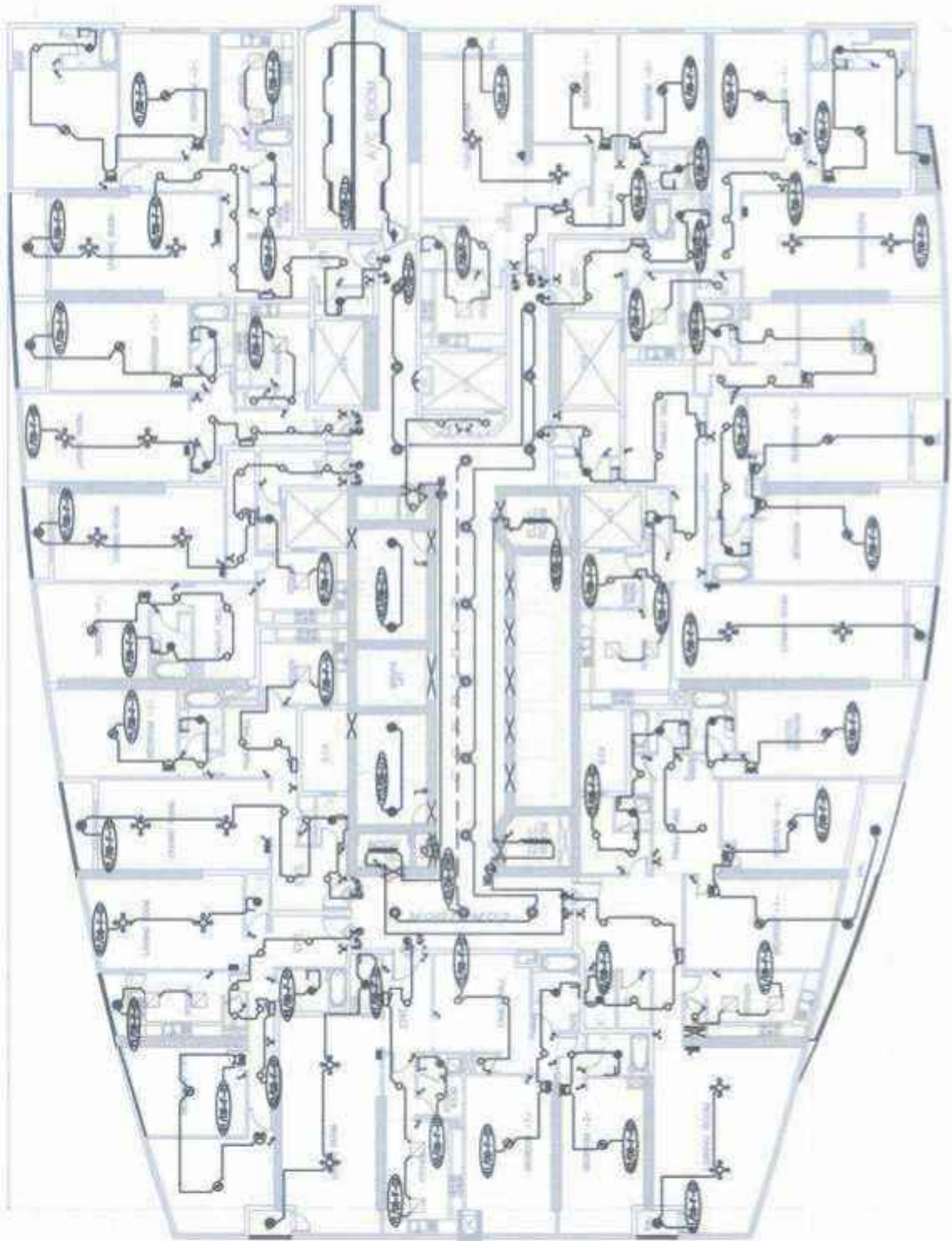

DUBAI PROJECT.

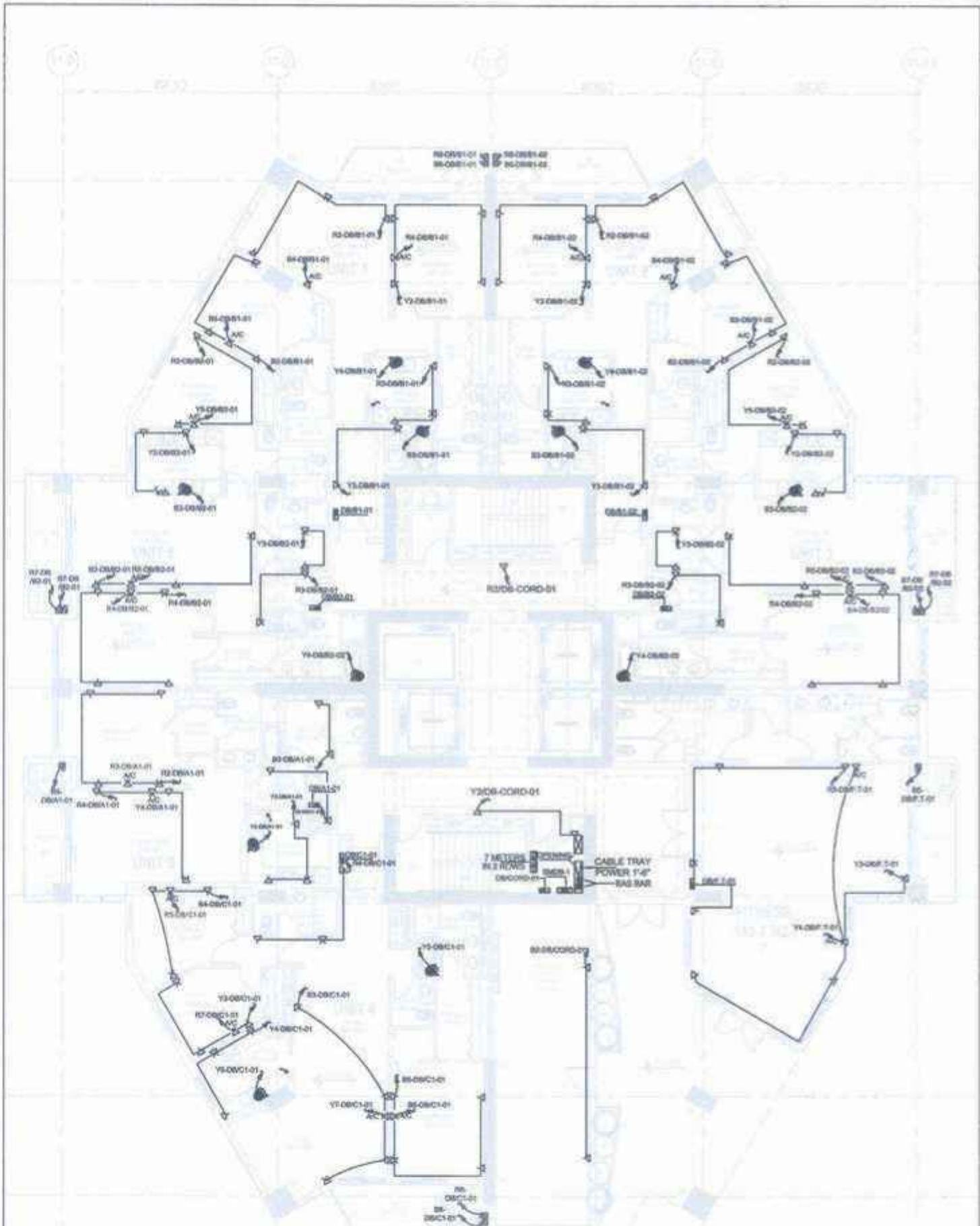

TOWER FLOOR PLAN  
 LEVEL 1 - TOWER 1  
 POWER LAYOUT  
 SCALE: 1/8"

CRESCENT BAY.

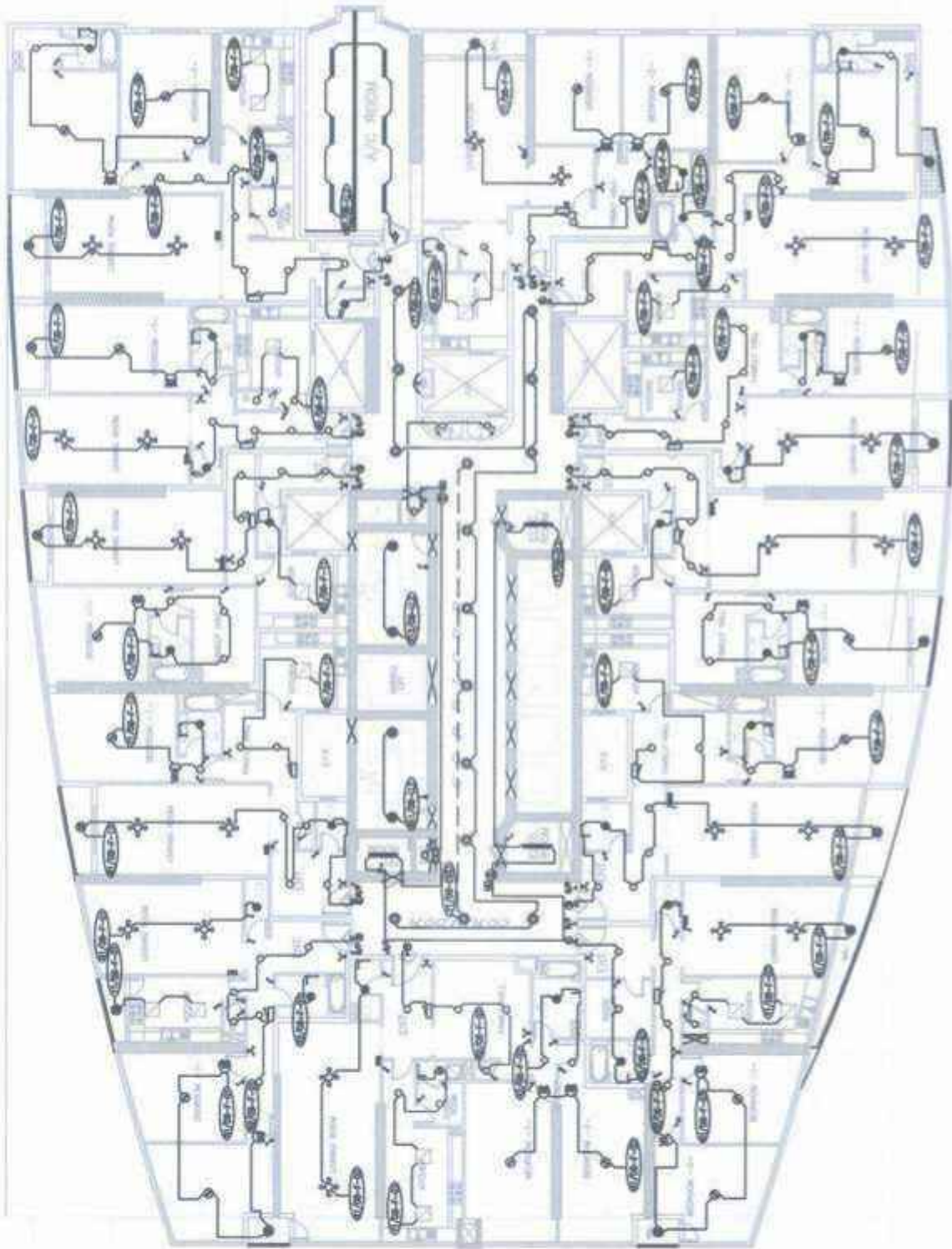

DUBAI PROJECT.

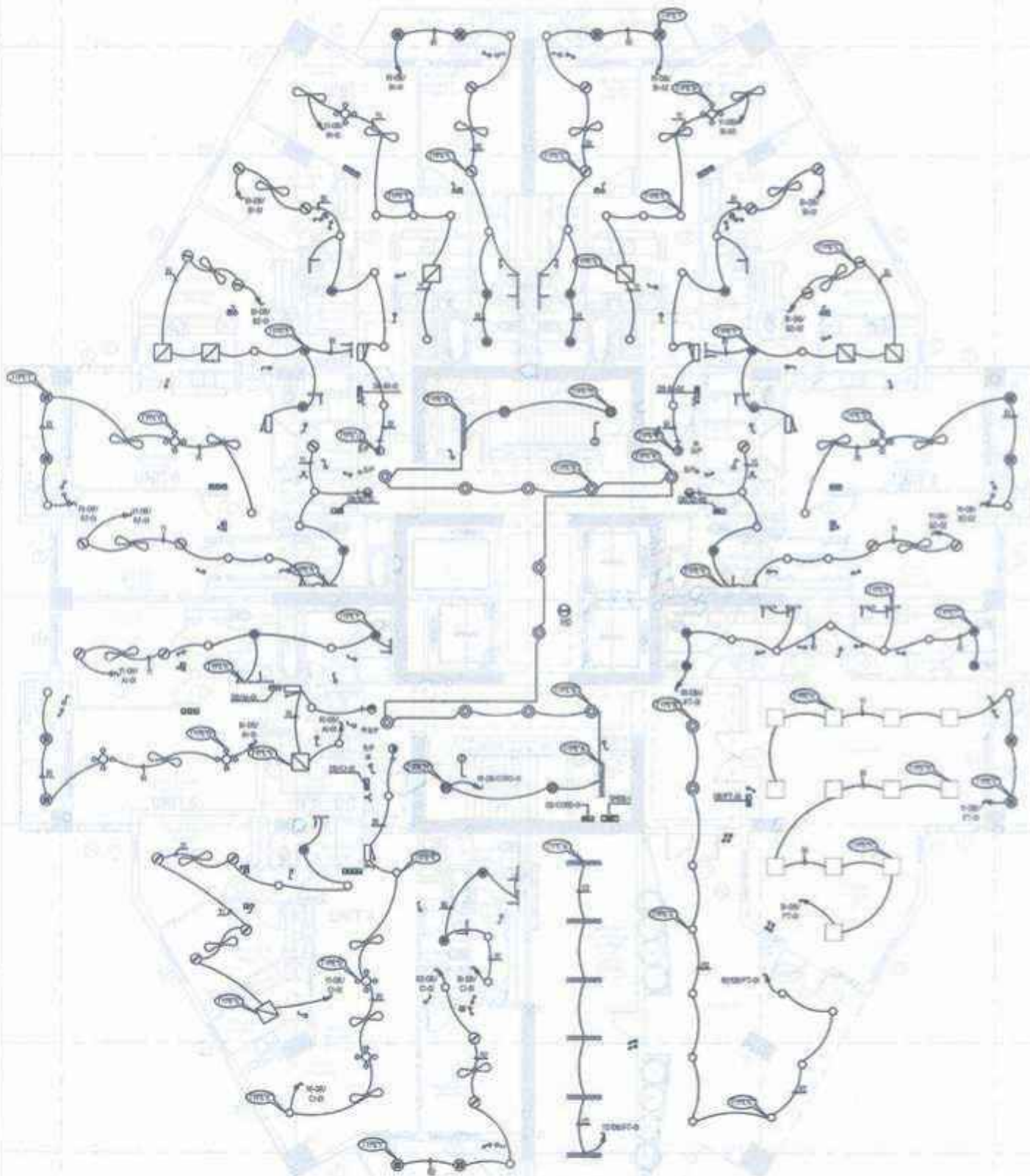

TOWER FLOOR PLAN  
 LEVEL 1 TOWER 1  
 LIGHTING LAYOUT  
 SCALE 1/8" = 1'-0"

CRESCENT BAY.

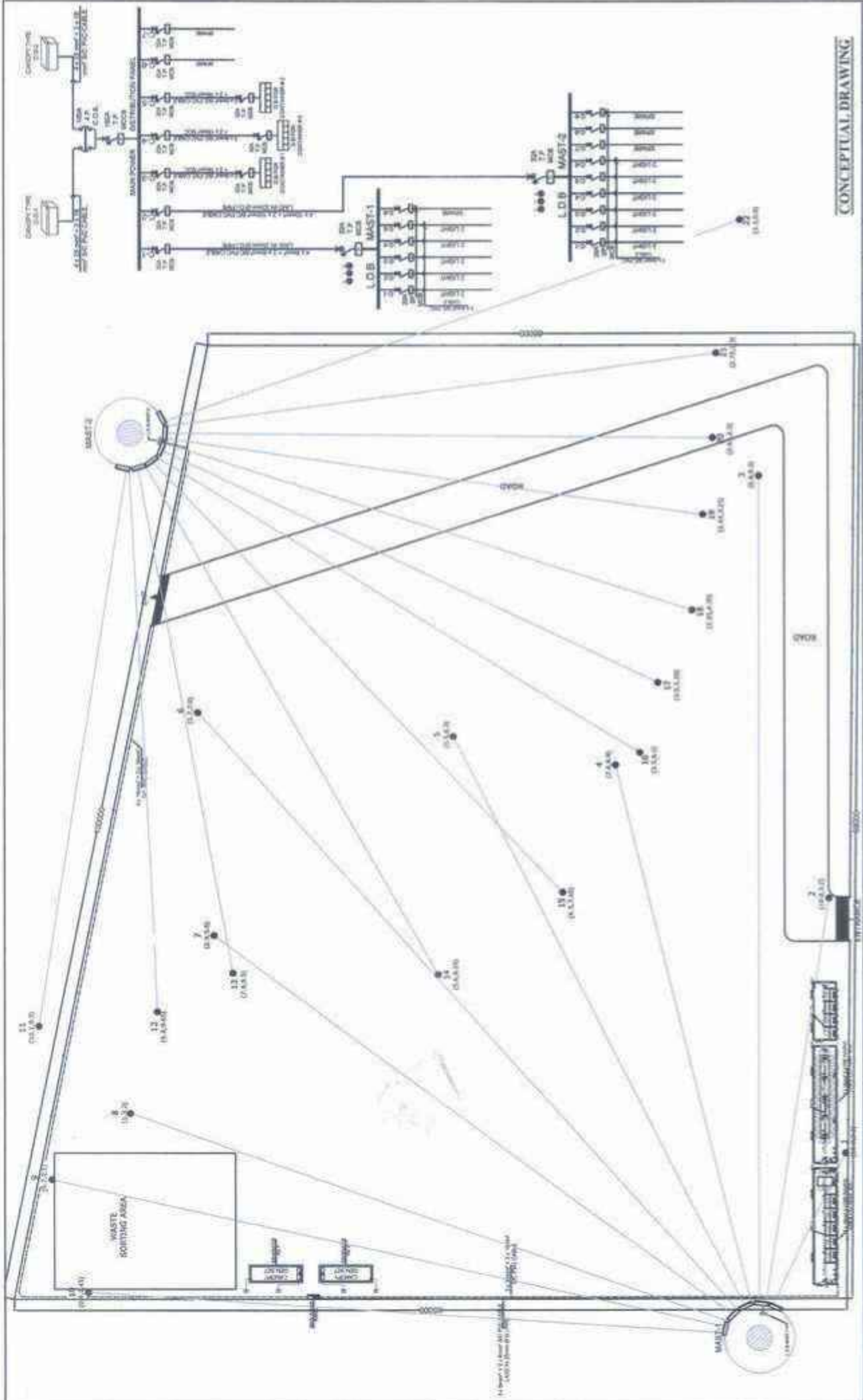

**CONCEPTUAL DRAWING**

	<b>ADVANCE ENGINEERING ASSOCIATES</b> ELECTRICAL ENGINEERS & ARCHITECTS 101, Ground Floor, Commercial Complex, Block 1, Phase 1, D.I. Khan, Islamabad.	<b>GAC Shipping Pakistan (Pvt.) Ltd</b> 8th Floor, K.I.I.C. Building, 30/31/32/33/34/35/36/37/38/39/40/41/42/43/44/45/46/47/48/49/50/51/52/53/54/55/56/57/58/59/60/61/62/63/64/65/66/67/68/69/70/71/72/73/74/75/76/77/78/79/80/81/82/83/84/85/86/87/88/89/90/91/92/93/94/95/96/97/98/99/100/101/102/103/104/105/106/107/108/109/110/111/112/113/114/115/116/117/118/119/120/121/122/123/124/125/126/127/128/129/130/131/132/133/134/135/136/137/138/139/140/141/142/143/144/145/146/147/148/149/150/151/152/153/154/155/156/157/158/159/160/161/162/163/164/165/166/167/168/169/170/171/172/173/174/175/176/177/178/179/180/181/182/183/184/185/186/187/188/189/190/191/192/193/194/195/196/197/198/199/200/201/202/203/204/205/206/207/208/209/210/211/212/213/214/215/216/217/218/219/220/221/222/223/224/225/226/227/228/229/230/231/232/233/234/235/236/237/238/239/240/241/242/243/244/245/246/247/248/249/250/251/252/253/254/255/256/257/258/259/260/261/262/263/264/265/266/267/268/269/270/271/272/273/274/275/276/277/278/279/280/281/282/283/284/285/286/287/288/289/290/291/292/293/294/295/296/297/298/299/300/301/302/303/304/305/306/307/308/309/310/311/312/313/314/315/316/317/318/319/320/321/322/323/324/325/326/327/328/329/330/331/332/333/334/335/336/337/338/339/340/341/342/343/344/345/346/347/348/349/350/351/352/353/354/355/356/357/358/359/360/361/362/363/364/365/366/367/368/369/370/371/372/373/374/375/376/377/378/379/380/381/382/383/384/385/386/387/388/389/390/391/392/393/394/395/396/397/398/399/400/401/402/403/404/405/406/407/408/409/410/411/412/413/414/415/416/417/418/419/420/421/422/423/424/425/426/427/428/429/430/431/432/433/434/435/436/437/438/439/440/441/442/443/444/445/446/447/448/449/450/451/452/453/454/455/456/457/458/459/460/461/462/463/464/465/466/467/468/469/470/471/472/473/474/475/476/477/478/479/480/481/482/483/484/485/486/487/488/489/490/491/492/493/494/495/496/497/498/499/500/501/502/503/504/505/506/507/508/509/510/511/512/513/514/515/516/517/518/519/520/521/522/523/524/525/526/527/528/529/530/531/532/533/534/535/536/537/538/539/540/541/542/543/544/545/546/547/548/549/550/551/552/553/554/555/556/557/558/559/560/561/562/563/564/565/566/567/568/569/570/571/572/573/574/575/576/577/578/579/580/581/582/583/584/585/586/587/588/589/590/591/592/593/594/595/596/597/598/599/600/601/602/603/604/605/606/607/608/609/610/611/612/613/614/615/616/617/618/619/620/621/622/623/624/625/626/627/628/629/630/631/632/633/634/635/636/637/638/639/640/641/642/643/644/645/646/647/648/649/650/651/652/653/654/655/656/657/658/659/660/661/662/663/664/665/666/667/668/669/670/671/672/673/674/675/676/677/678/679/680/681/682/683/684/685/686/687/688/689/690/691/692/693/694/695/696/697/698/699/700/701/702/703/704/705/706/707/708/709/710/711/712/713/714/715/716/717/718/719/720/721/722/723/724/725/726/727/728/729/730/731/732/733/734/735/736/737/738/739/740/741/742/743/744/745/746/747/748/749/750/751/752/753/754/755/756/757/758/759/760/761/762/763/764/765/766/767/768/769/770/771/772/773/774/775/776/777/778/779/780/781/782/783/784/785/786/787/788/789/790/791/792/793/794/795/796/797/798/799/800/801/802/803/804/805/806/807/808/809/810/811/812/813/814/815/816/817/818/819/820/821/822/823/824/825/826/827/828/829/830/831/832/833/834/835/836/837/838/839/840/841/842/843/844/845/846/847/848/849/850/851/852/853/854/855/856/857/858/859/860/861/862/863/864/865/866/867/868/869/870/871/872/873/874/875/876/877/878/879/880/881/882/883/884/885/886/887/888/889/890/891/892/893/894/895/896/897/898/899/900/901/902/903/904/905/906/907/908/909/910/911/912/913/914/915/916/917/918/919/920/921/922/923/924/925/926/927/928/929/930/931/932/933/934/935/936/937/938/939/940/941/942/943/944/945/946/947/948/949/950/951/952/953/954/955/956/957/958/959/960/961/962/963/964/965/966/967/968/969/970/971/972/973/974/975/976/977/978/979/980/981/982/983/984/985/986/987/988/989/990/991/992/993/994/995/996/997/998/999/1000/1001/1002/1003/1004/1005/1006/1007/1008/1009/1010/1011/1012/1013/1014/1015/1016/1017/1018/1019/1020/1021/1022/1023/1024/1025/1026/1027/1028/1029/1030/1031/1032/1033/1034/1035/1036/1037/1038/1039/1040/1041/1042/1043/1044/1045/1046/1047/1048/1049/1050/1051/1052/1053/1054/1055/1056/1057/1058/1059/1060/1061/1062/1063/1064/1065/1066/1067/1068/1069/1070/1071/1072/1073/1074/1075/1076/1077/1078/1079/1080/1081/1082/1083/1084/1085/1086/1087/1088/1089/1090/1091/1092/1093/1094/1095/1096/1097/1098/1099/1100/1101/1102/1103/1104/1105/1106/1107/1108/1109/1110/1111/1112/1113/1114/1115/1116/1117/1118/1119/1120/1121/1122/1123/1124/1125/1126/1127/1128/1129/1130/1131/1132/1133/1134/1135/1136/1137/1138/1139/1140/1141/1142/1143/1144/1145/1146/1147/1148/1149/1150/1151/1152/1153/1154/1155/1156/1157/1158/1159/1160/1161/1162/1163/1164/1165/1166/1167/1168/1169/1170/1171/1172/1173/1174/1175/1176/1177/1178/1179/1180/1181/1182/1183/1184/1185/1186/1187/1188/1189/1190/1191/1192/1193/1194/1195/1196/1197/1198/1199/1200/1201/1202/1203/1204/1205/1206/1207/1208/1209/1210/1211/1212/1213/1214/1215/1216/1217/1218/1219/1220/1221/1222/1223/1224/1225/1226/1227/1228/1229/1230/1231/1232/1233/1234/1235/1236/1237/1238/1239/1240/1241/1242/1243/1244/1245/1246/1247/1248/1249/1250/1251/1252/1253/1254/1255/1256/1257/1258/1259/1260/1261/1262/1263/1264/1265/1266/1267/1268/1269/1270/1271/1272/1273/1274/1275/1276/1277/1278/1279/1280/1281/1282/1283/1284/1285/1286/1287/1288/1289/1290/1291/1292/1293/1294/1295/1296/1297/1298/1299/1300/1301/1302/1303/1304/1305/1306/1307/1308/1309/1310/1311/1312/1313/1314/1315/1316/1317/1318/1319/1320/1321/1322/1323/1324/1325/1326/1327/1328/1329/1330/1331/1332/1333/1334/1335/1336/1337/1338/1339/1340/1341/1342/1343/1344/1345/1346/1347/1348/1349/1350/1351/1352/1353/1354/1355/1356/1357/1358/1359/1360/1361/1362/1363/1364/1365/1366/1367/1368/1369/1370/1371/1372/1373/1374/1375/1376/1377/1378/1379/1380/1381/1382/1383/1384/1385/1386/1387/1388/1389/1390/1391/1392/1393/1394/1395/1396/1397/1398/1399/1400/1401/1402/1403/1404/1405/1406/1407/1408/1409/1410/1411/1412/1413/1414/1415/1416/1417/1418/1419/1420/1421/1422/1423/1424/1425/1426/1427/1428/1429/1430/1431/1432/1433/1434/1435/1436/1437/1438/1439/1440/1441/1442/1443/1444/1445/1446/1447/1448/1449/1450/1451/1452/1453/1454/1455/1456/1457/1458/1459/1460/1461/1462/1463/1464/1465/1466/1467/1468/1469/1470/1471/1472/1473/1474/1475/1476/1477/1478/1479/1480/1481/1482/1483/1484/1485/1486/1487/1488/1489/1490/1491/1492/1493/1494/1495/1496/1497/1498/1499/1500/1501/1502/1503/1504/1505/1506/1507/1508/1509/1510/1511/1512/1513/1514/1515/1516/1517/1518/1519/1520/1521/1522/1523/1524/1525/1526/1527/1528/1529/1530/1531/1532/1533/1534/1535/1536/1537/1538/1539/1540/1541/1542/1543/1544/1545/1546/1547/1548/1549/1550/1551/1552/1553/1554/1555/1556/1557/1558/1559/1560/1561/1562/1563/1564/1565/1566/1567/1568/1569/1570/1571/1572/1573/1574/1575/1576/1577/1578/1579/1580/1581/1582/1583/1584/1585/1586/1587/1588/1589/1590/1591/1592/1593/1594/1595/1596/1597/1598/1599/1600/1601/1602/1603/1604/1605/1606/1607/1608/1609/1610/1611/1612/1613/1614/1615/1616/1617/1618/1619/1620/1621/1622/1623/1624/1625/1626/1627/1628/1629/1630/1631/1632/1633/1634/1635/1636/1637/1638/1639/1640/1641/1642/1643/1644/1645/1646/1647/1648/1649/1650/1651/1652/1653/1654/1655/1656/1657/1658/1659/1660/1661/1662/1663/1664/1665/1666/1667/1668/1669/1670/1671/1672/1673/1674/1675/1676/1677/1678/1679/1680/1681/1682/1683/1684/1685/1686/1687/1688/1689/1690/1691/1692/1693/1694/1695/1696/1697/1698/1699/1700/1701/1702/1703/1704/1705/1706/1707/1708/1709/1710/1711/1712/1713/1714/1715/1716/1717/1718/1719/1720/1721/1722/1723/1724/1725/1726/1727/1728/1729/1730/1731/1732/1733/1734/1735/1736/1737/1738/1739/1740/1741/1742/1743/1744/1745/1746/1747/1748/1749/1750/1751/1752/1753/1754/1755/1756/1757/1758/1759/1760/1761/1762/1763/1764/1765/1766/1767/1768/1769/1770/1771/1772/1773/1774/1775/1776/1777/1778/1779/1780/1781/1782/1783/1784/1785/1786/1787/1788/1789/1790/1791/1792/1793/1794/1795/1796/1797/1798/1799/1800/1801/1802/1803/1804/1805/1806/1807/1808/1809/1810/1811/1812/1813/1814/1815/1816/1817/1818/1819/1820/1821/1822/1823/1824/1825/1826/1827/1828/1829/1830/1831/1832/1833/1834/1835/1836/1837/1838/1839/1840/1841/1842/1843/1844/1845/1846/1847/1848/1849/1850/1851/1852/1853/1854/1855/1856/1857/1858/1859/1860/1861/1862/1863/1864/1865/1866/1867/1868/1869/1870/1871/1872/1873/1874/1875/1876/1877/1878/1879/1880/1881/1882/1883/1884/1885/1886/1887/1888/1889/1890/1891/1892/1893/1894/1895/1896/1897/1898/1899/1900/1901/1902/1903/1904/1905/1906/1907/1908/1909/1910/1911/1912/1913/1914/1915/1916/1917/1918/1919/1920/1921/1922/1923/1924/1925/1926/1927/1928/1929/1930/1931/1932/1933/1934/1935/1936/1937/1938/1939/1940/1941/1942/1943/1944/1945/1946/1947/1948/1949/1950/1951/1952/1953/1954/1955/1956/1957/1958/1959/1960/1961/1962/1963/1964/1965/1966/1967/1968/1969/1970/1971/1972/1973/1974/1975/1976/1977/1978/1979/1980/1981/1982/1983/1984/1985/1986/1987/1988/1989/1990/1991/1992/1993/1994/1995/1996/1997/1998/1999/2000/2001/2002/2003/2004/2005/2006/2007/2008/2009/2010/2011/2012/2013/2014/2015/2016/2017/2018/2019/2020/2021/2022/2023/2024/2025/2026/2027/2028/2029/2030/2031/2032/2033/2034/2035/2036/2037/2038/2039/2040/2041/2042/2043/2044/2045/2046/2047/2048/2049/2050/2051/2052/2053/2054/2055/2056/2057/2058/2059/2060/2061/2062/2063/2064/2065/2066/2067/2068/2069/2070/2071/2072/2073/2074/2075/2076/2077/2078/2079/2080/2081/2082/2083/2084/2085/2086/2087/2088/2089/2090/2091/2092/2093/2094/2095/2096/2097/2098/2099/2100/2101/2102/2103/2104/2105/2106/2107/2108/2109/2110/2111/2112/2113/2114/2115/2116/2117/2118/2119/2120/2121/2122/2123/2124/2125/2126/2127/2128/2129/2130/2131/2132/2133/2134/2135/2136/2137/2138/2139/2140/2141/2142/2143/2144/2145/2146/2147/2148/2149/2150/2151/2152/2153/2154/2155/2156/2157/2158/2159/2160/2161/2162/2163/2164/2165/2166/2167/2168/2169/2170/2171/2172/2173/2174/2175/2176/2177/2178/2179/2180/2181/2182/2183/2184/2185/2186/2187/2188/2189/2190/2191/2192/2193/2194/2195/2196/2197/2198/2199/2200/2201/2202/2203/2204/2205/2206/2207/2208/2209/2210/2211/2212/2213/2214/2215/2216/2217/2218/2219/2220/2221/2222/2223/2224/2225/2226/2227/2228/2229/2230/2231/2232/2233/2234/2235/2236/2237/2238/2239/2240/2241/2242/2243/2244/2245/2246/2247/2248/2249/2250/2251/2252/2253/2254/2255/2256/2257/2258/2259/2260/2261/2262/2263/2264/2265/2266/2267/2268/2269/2270/2271/2272/2273/2274/2275/2276/2277/2278/2279/2280/2281/2282/2283/2284/2285/2286/2287/2288/2289/2290/2291/2292/2293/2294/2295/2296/2297/2298/2299/2300/2301/2302/2303/2304/2305/2306/2307/2308/2309/2310/2311/2312/2313/2314/2315/2316/2317/2318/2319/2320/2321/2322/2323/2324/2325/2326/2327/2328/2329/2330/2331/2332/2333/2334/2335/2336/2337/2338/2339/2340/2341/2342/2343/2344/2345/2346/2347/2348/2349/2350/2351/2352/2353/2354/2355/2356/2357/2358/2359/2360/2361/2362/2363/2364/2365/2366/2367/2368/2369/2370/2371/2372/2373/2374/2375/2376/2377/2378/2379/2380/2381/2382/2383/2384/2385/2386/2387/2388/2389/2390/2391/2392/2393/2394/2395/2396/2397/2398/2399/2400/2401/2402/2403/2404/2405/2406/2407/2408/2409/2410/2411/2412/2413/2414/2415/2416/2417/2418/2419/2420/2421/2422/2423/2424/2425/2426/2427/2428/2429/2430/2431/2432/2433/2434/2435/2436/2437/2438/2439/2440/2441/2442/2443/2444/2445/2446/2447/2448/2449/2450/2451/2452/2453/2454/2455/2456/2457/2458/2459/2460/2461/2462/2463/2464/2465/2466/2467/2468/2469/2470/2471/2472/2473/2474/2475/2476/2477/2478/2479/2480/2481/2482/2483/2484/2485/2486/2487/2488/2489/2490/2491/2492/2493/2494/2495/2496/2497/2498/2499/2500/2501/2502/2503/2504/2505/2506/2507/2508/2509/2510/2511/2512/2513/2514/2515/2516/2517/2518/2519/2520/2521/2522/2523/2524/2525/2526/2527/2528/2529/2530/2531/2532/2533/2534/2535/2536/2537/2538/2539/2540/2541/2542/2543/2544/2545/2546/2547/2548/2549/2550/2551/2552/2553/2554/2555/2556/2557/2558/2559/2560/2561/2562/2563/2564/2565/2566/2567/2568/2569/2570/2571/2572/2573/2574/2575/2576/2577/2578/2579/2580/2581/2582/2583/2584/2585/2586/2587/2588/2589/2590/2591/2592/2593/2594/2595/2596/2597/2598/2599/2600/2601/2602/2603/2604/2605/2606/2607/2608/2609/2610/2611/2612/2613/2614/2615/2616/2617/2618/2619/2620/2621/2622/2623/2624/2625/2626/2627/2628/2629/2630/2631/2632/2633/2634/2635/2636/2637/2
--	--	--

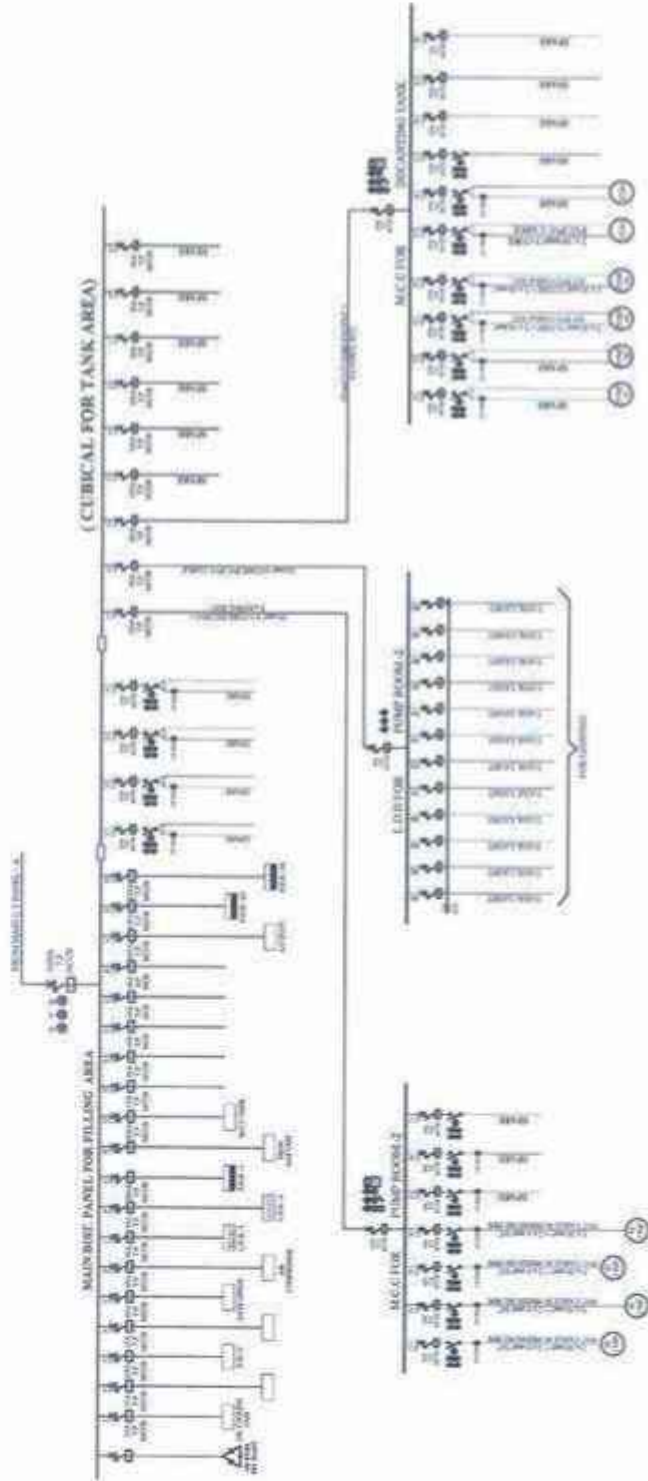
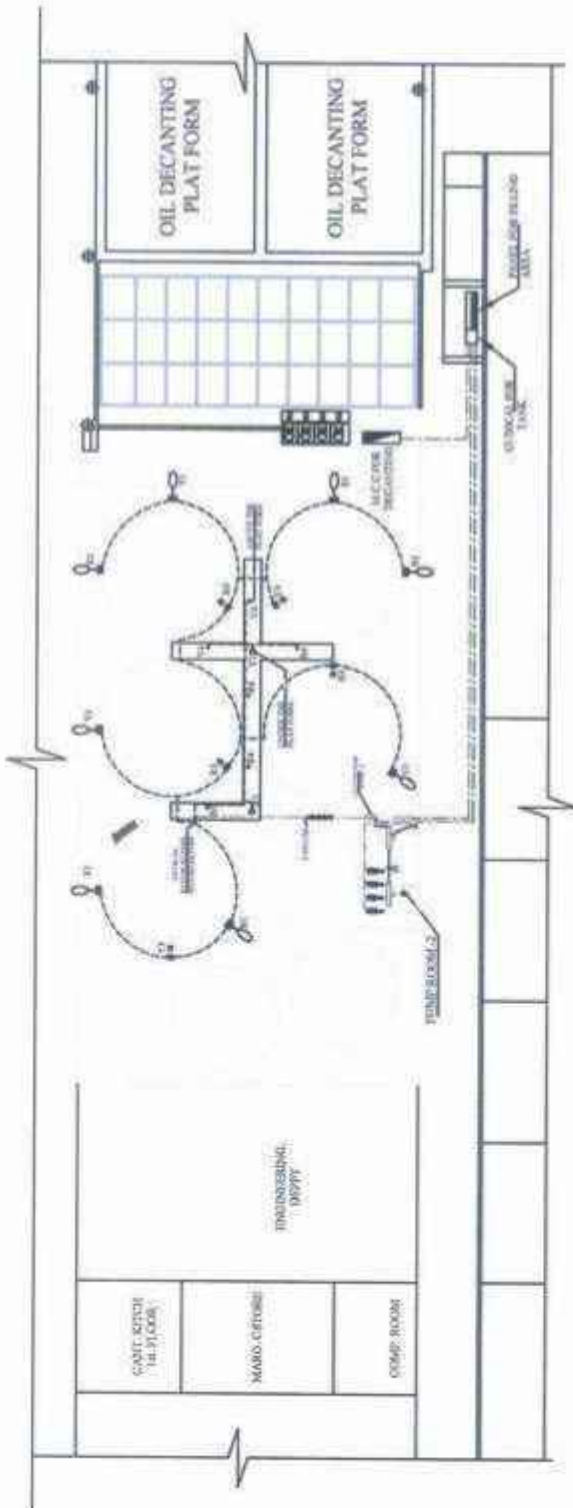

	<b>HARRIS MILLS (PTY) LTD</b> SUBSIDIARY OF HARVEY NORMAN GROUP	<b>ADVANCE ENGINEERING ASSOCIATES</b> 100, 101, 102, 103, 104, 105, 106, 107, 108, 109, 110, 111, 112, 113, 114, 115, 116, 117, 118, 119, 120, 121, 122, 123, 124, 125, 126, 127, 128, 129, 130, 131, 132, 133, 134, 135, 136, 137, 138, 139, 140, 141, 142, 143, 144, 145, 146, 147, 148, 149, 150, 151, 152, 153, 154, 155, 156, 157, 158, 159, 160, 161, 162, 163, 164, 165, 166, 167, 168, 169, 170, 171, 172, 173, 174, 175, 176, 177, 178, 179, 180, 181, 182, 183, 184, 185, 186, 187, 188, 189, 190, 191, 192, 193, 194, 195, 196, 197, 198, 199, 200, 201, 202, 203, 204, 205, 206, 207, 208, 209, 210, 211, 212, 213, 214, 215, 216, 217, 218, 219, 220, 221, 222, 223, 224, 225, 226, 227, 228, 229, 230, 231, 232, 233, 234, 235, 236, 237, 238, 239, 240, 241, 242, 243, 244, 245, 246, 247, 248, 249, 250, 251, 252, 253, 254, 255, 256, 257, 258, 259, 260, 261, 262, 263, 264, 265, 266, 267, 268, 269, 270, 271, 272, 273, 274, 275, 276, 277, 278, 279, 280, 281, 282, 283, 284, 285, 286, 287, 288, 289, 290, 291, 292, 293, 294, 295, 296, 297, 298, 299, 300, 301, 302, 303, 304, 305, 306, 307, 308, 309, 310, 311, 312, 313, 314, 315, 316, 317, 318, 319, 320, 321, 322, 323, 324, 325, 326, 327, 328, 329, 330, 331, 332, 333, 334, 335, 336, 337, 338, 339, 340, 341, 342, 343, 344, 345, 346, 347, 348, 349, 350, 351, 352, 353, 354, 355, 356, 357, 358, 359, 360, 361, 362, 363, 364, 365, 366, 367, 368, 369, 370, 371, 372, 373, 374, 375, 376, 377, 378, 379, 380, 381, 382, 383, 384, 385, 386, 387, 388, 389, 390, 391, 392, 393, 394, 395, 396, 397, 398, 399, 400, 401, 402, 403, 404, 405, 406, 407, 408, 409, 410, 411, 412, 413, 414, 415, 416, 417, 418, 419, 420, 421, 422, 423, 424, 425, 426, 427, 428, 429, 430, 431, 432, 433, 434, 435, 436, 437, 438, 439, 440, 441, 442, 443, 444, 445, 446, 447, 448, 449, 450, 451, 452, 453, 454, 455, 456, 457, 458, 459, 460, 461, 462, 463, 464, 465, 466, 467, 468, 469, 470, 471, 472, 473, 474, 475, 476, 477, 478, 479, 480, 481, 482, 483, 484, 485, 486, 487, 488, 489, 490, 491, 492, 493, 494, 495, 496, 497, 498, 499, 500, 501, 502, 503, 504, 505, 506, 507, 508, 509, 510, 511, 512, 513, 514, 515, 516, 517, 518, 519, 520, 521, 522, 523, 524, 525, 526, 527, 528, 529, 530, 531, 532, 533, 534, 535, 536, 537, 538, 539, 540, 541, 542, 543, 544, 545, 546, 547, 548, 549, 550, 551, 552, 553, 554, 555, 556, 557, 558, 559, 560, 561, 562, 563, 564, 565, 566, 567, 568, 569, 570, 571, 572, 573, 574, 575, 576, 577, 578, 579, 580, 581, 582, 583, 584, 585, 586, 587, 588, 589, 590, 591, 592, 593, 594, 595, 596, 597, 598, 599, 600, 601, 602, 603, 604, 605, 606, 607, 608, 609, 610, 611, 612, 613, 614, 615, 616, 617, 618, 619, 620, 621, 622, 623, 624, 625, 626, 627, 628, 629, 630, 631, 632, 633, 634, 635, 636, 637, 638, 639, 640, 641, 642, 643, 644, 645, 646, 647, 648, 649, 650, 651, 652, 653, 654, 655, 656, 657, 658, 659, 660, 661, 662, 663, 664, 665, 666, 667, 668, 669, 670, 671, 672, 673, 674, 675, 676, 677, 678, 679, 680, 681, 682, 683, 684, 685, 686, 687, 688, 689, 690, 691, 692, 693, 694, 695, 696, 697, 698, 699, 700, 701, 702, 703, 704, 705, 706, 707, 708, 709, 710, 711, 712, 713, 714, 715, 716, 717, 718, 719, 720, 721, 722, 723, 724, 725, 726, 727, 728, 729, 730, 731, 732, 733, 734, 735, 736, 737, 738, 739, 740, 741, 742, 743, 744, 745, 746, 747, 748, 749, 750, 751, 752, 753, 754, 755, 756, 757, 758, 759, 760, 761, 762, 763, 764, 765, 766, 767, 768, 769, 770, 771, 772, 773, 774, 775, 776, 777, 778, 779, 780, 781, 782, 783, 784, 785, 786, 787, 788, 789, 790, 791, 792, 793, 794, 795, 796, 797, 798, 799, 800, 801, 802, 803, 804, 805, 806, 807, 808, 809, 810, 811, 812, 813, 814, 815, 816, 817, 818, 819, 820, 821, 822, 823, 824, 825, 826, 827, 828, 829, 830, 831, 832, 833, 834, 835, 836, 837, 838, 839, 840, 841, 842, 843, 844, 845, 846, 847, 848, 849, 850, 851, 852, 853, 854, 855, 856, 857, 858, 859, 860, 861, 862, 863, 864, 865, 866, 867, 868, 869, 870, 871, 872, 873, 874, 875, 876, 877, 878, 879, 880, 881, 882, 883, 884, 885, 886, 887, 888, 889, 890, 891, 892, 893, 894, 895, 896, 897, 898, 899, 900, 901, 902, 903, 904, 905, 906, 907, 908, 909, 910, 911, 912, 913, 914, 915, 916, 917, 918, 919, 920, 921, 922, 923, 924, 925, 926, 927, 928, 929, 930, 931, 932, 933, 934, 935, 936, 937, 938, 939, 940, 941, 942, 943, 944, 945, 946, 947, 948, 949, 950, 951, 952, 953, 954, 955, 956, 957, 958, 959, 960, 961, 962, 963, 964, 965, 966, 967, 968, 969, 970, 971, 972, 973, 974, 975, 976, 977, 978, 979, 980, 981, 982, 983, 984, 985, 986, 987, 988, 989, 990, 991, 992, 993, 994, 995, 996, 997, 998, 999, 1000	<b>PROPOSED ELECTRICAL WORKS FOR THE BEESKEY BUILDING &amp; STORAGE TANK</b>	<b>TANK AREA LIGHTING &amp; POWER PLAN (AS-BUILT)</b>	DATE: 15/01/2010 DRAWN: [Name] CHECKED: [Name] APPROVED: [Name]	SHEET NO: 0177 OF 0177

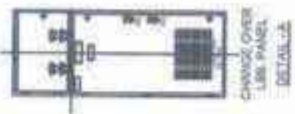

10/12/12 MVO

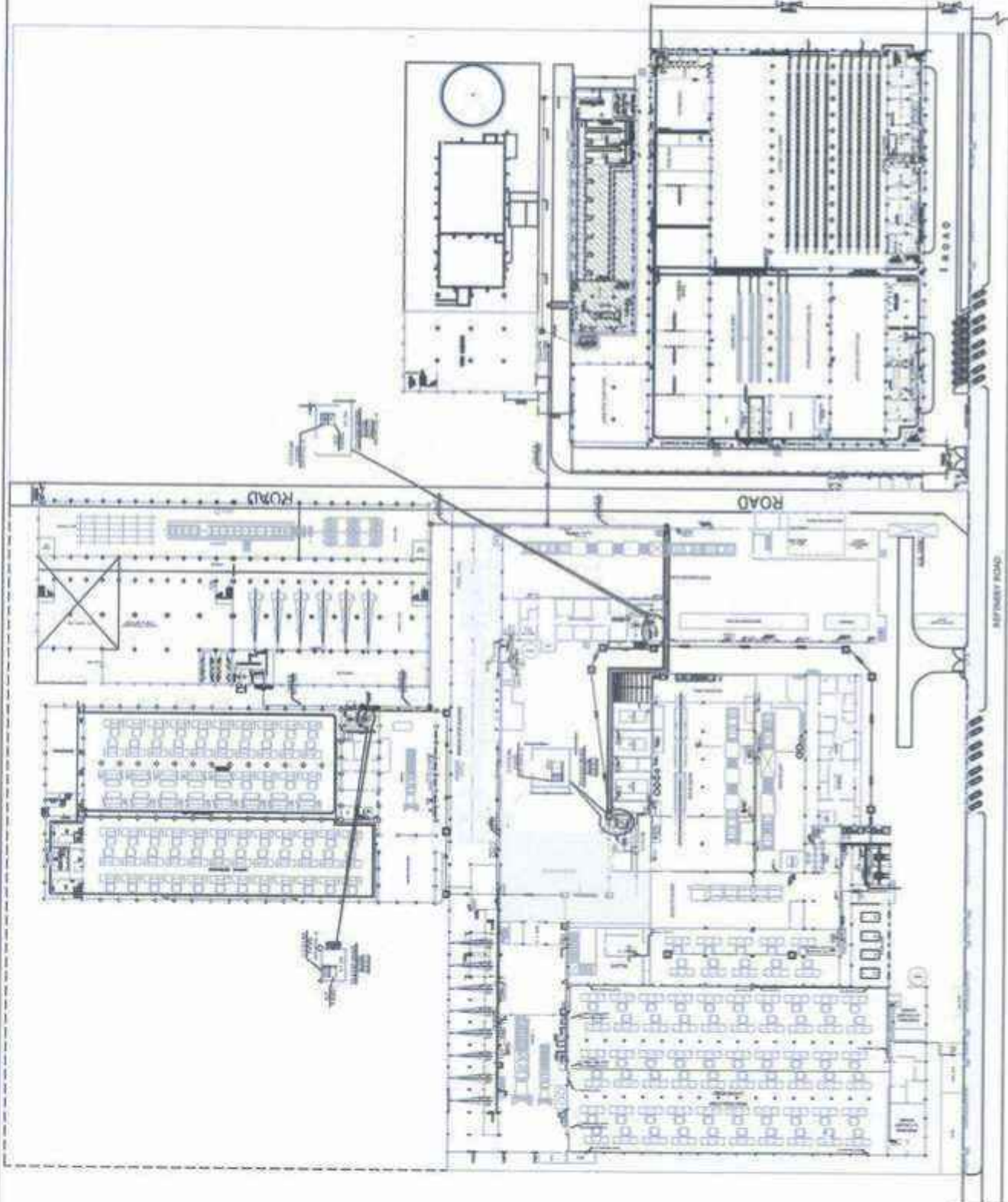

 <b>Advance Engineering Associates</b> 10000 W. 11th Avenue, Suite 100 Denver, CO 80202 Tel: 303.751.1111 Fax: 303.751.1112 www.advanceeng.com	PROJECT NO. <b>0009</b> DATE <b>10/12/12</b> DRAWN BY <b>MM</b> CHECKED BY <b>MM</b> APPROVED BY <b>MM</b> TITLE <b>ADN-8-01</b>
	PROJECT NAME <b>UP-GRADATION OF POWER DISTRIBUTION NETWORK</b> PROJECT LOCATION <b>SITE PLAN WITH LOCATION OF C.O.S. LINE PANEL (PROPOSED)</b> PROJECT NUMBER <b>1-000</b> PROJECT SCALE <b>1"=80'</b> PROJECT STATUS <b>Final</b> PROJECT DESCRIPTION <b>This plan represents all items having a been reviewed.</b>



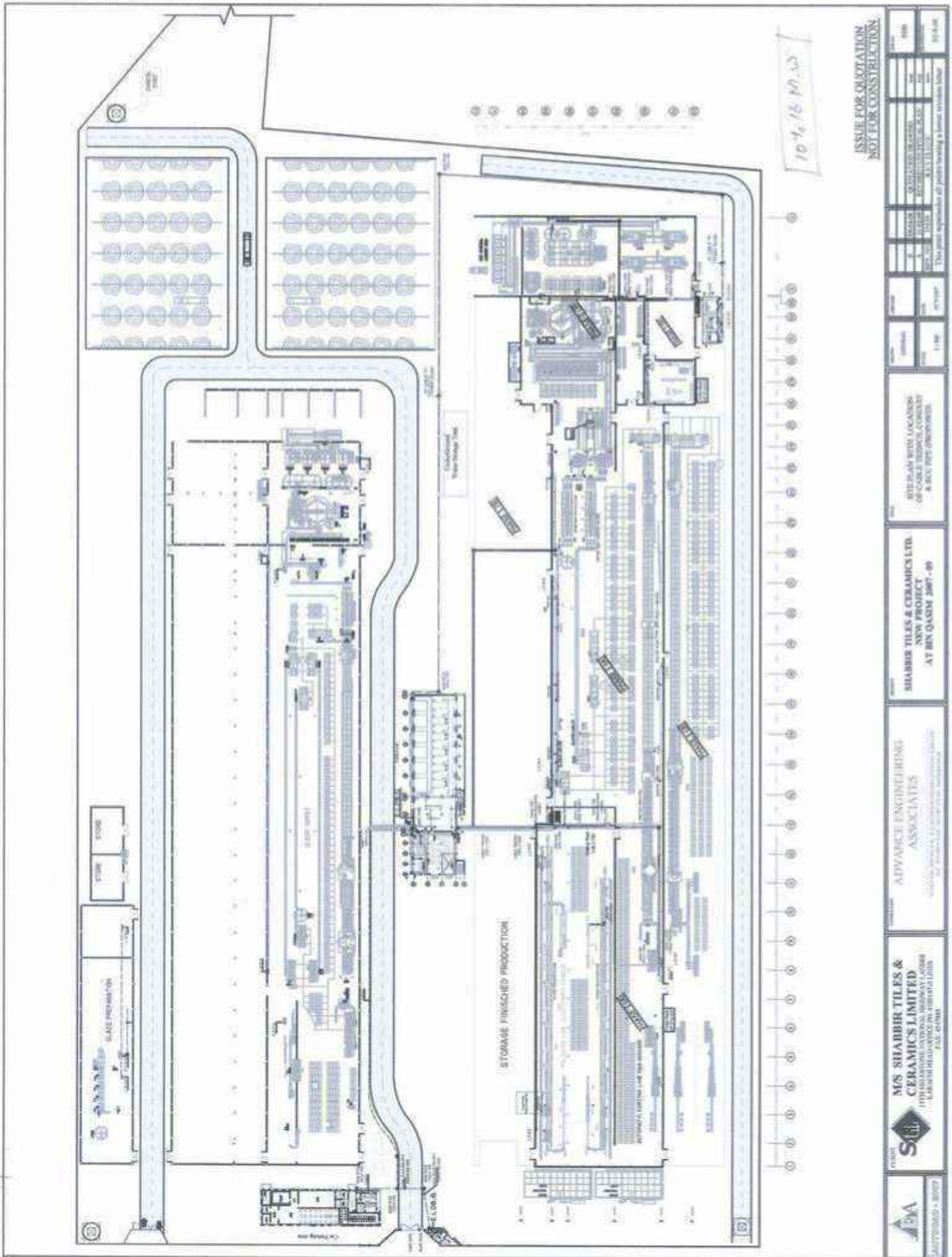

ISSUE FOR QUOTATION  
NOT FOR CONSTRUCTION

 <b>M/S SHABIBR TILES &amp; CERAMICS LIMITED</b> (PVT) LTD. EXTENSION, MIDWAY LADDER LAHORE HEADQUARTERS IN ABBOTT ROAD P.O. BOX 1000	ADVANCE ENGINEERING ASSOCIATES 100, 101, 102, 103, 104, 105, 106, 107, 108, 109, 110, 111, 112, 113, 114, 115, 116, 117, 118, 119, 120, 121, 122, 123, 124, 125, 126, 127, 128, 129, 130, 131, 132, 133, 134, 135, 136, 137, 138, 139, 140, 141, 142, 143, 144, 145, 146, 147, 148, 149, 150, 151, 152, 153, 154, 155, 156, 157, 158, 159, 160, 161, 162, 163, 164, 165, 166, 167, 168, 169, 170, 171, 172, 173, 174, 175, 176, 177, 178, 179, 180, 181, 182, 183, 184, 185, 186, 187, 188, 189, 190, 191, 192, 193, 194, 195, 196, 197, 198, 199, 200, 201, 202, 203, 204, 205, 206, 207, 208, 209, 210, 211, 212, 213, 214, 215, 216, 217, 218, 219, 220, 221, 222, 223, 224, 225, 226, 227, 228, 229, 230, 231, 232, 233, 234, 235, 236, 237, 238, 239, 240, 241, 242, 243, 244, 245, 246, 247, 248, 249, 250, 251, 252, 253, 254, 255, 256, 257, 258, 259, 260, 261, 262, 263, 264, 265, 266, 267, 268, 269, 270, 271, 272, 273, 274, 275, 276, 277, 278, 279, 280, 281, 282, 283, 284, 285, 286, 287, 288, 289, 290, 291, 292, 293, 294, 295, 296, 297, 298, 299, 300, 301, 302, 303, 304, 305, 306, 307, 308, 309, 310, 311, 312, 313, 314, 315, 316, 317, 318, 319, 320, 321, 322, 323, 324, 325, 326, 327, 328, 329, 330, 331, 332, 333, 334, 335, 336, 337, 338, 339, 340, 341, 342, 343, 344, 345, 346, 347, 348, 349, 350, 351, 352, 353, 354, 355, 356, 357, 358, 359, 360, 361, 362, 363, 364, 365, 366, 367, 368, 369, 370, 371, 372, 373, 374, 375, 376, 377, 378, 379, 380, 381, 382, 383, 384, 385, 386, 387, 388, 389, 390, 391, 392, 393, 394, 395, 396, 397, 398, 399, 400, 401, 402, 403, 404, 405, 406, 407, 408, 409, 410, 411, 412, 413, 414, 415, 416, 417, 418, 419, 420, 421, 422, 423, 424, 425, 426, 427, 428, 429, 430, 431, 432, 433, 434, 435, 436, 437, 438, 439, 440, 441, 442, 443, 444, 445, 446, 447, 448, 449, 450, 451, 452, 453, 454, 455, 456, 457, 458, 459, 460, 461, 462, 463, 464, 465, 466, 467, 468, 469, 470, 471, 472, 473, 474, 475, 476, 477, 478, 479, 480, 481, 482, 483, 484, 485, 486, 487, 488, 489, 490, 491, 492, 493, 494, 495, 496, 497, 498, 499, 500, 501, 502, 503, 504, 505, 506, 507, 508, 509, 510, 511, 512, 513, 514, 515, 516, 517, 518, 519, 520, 521, 522, 523, 524, 525, 526, 527, 528, 529, 530, 531, 532, 533, 534, 535, 536, 537, 538, 539, 540, 541, 542, 543, 544, 545, 546, 547, 548, 549, 550, 551, 552, 553, 554, 555, 556, 557, 558, 559, 560, 561, 562, 563, 564, 565, 566, 567, 568, 569, 570, 571, 572, 573, 574, 575, 576, 577, 578, 579, 580, 581, 582, 583, 584, 585, 586, 587, 588, 589, 590, 591, 592, 593, 594, 595, 596, 597, 598, 599, 600, 601, 602, 603, 604, 605, 606, 607, 608, 609, 610, 611, 612, 613, 614, 615, 616, 617, 618, 619, 620, 621, 622, 623, 624, 625, 626, 627, 628, 629, 630, 631, 632, 633, 634, 635, 636, 637, 638, 639, 640, 641, 642, 643, 644, 645, 646, 647, 648, 649, 650, 651, 652, 653, 654, 655, 656, 657, 658, 659, 660, 661, 662, 663, 664, 665, 666, 667, 668, 669, 670, 671, 672, 673, 674, 675, 676, 677, 678, 679, 680, 681, 682, 683, 684, 685, 686, 687, 688, 689, 690, 691, 692, 693, 694, 695, 696, 697, 698, 699, 700, 701, 702, 703, 704, 705, 706, 707, 708, 709, 710, 711, 712, 713, 714, 715, 716, 717, 718, 719, 720, 721, 722, 723, 724, 725, 726, 727, 728, 729, 730, 731, 732, 733, 734, 735, 736, 737, 738, 739, 740, 741, 742, 743, 744, 745, 746, 747, 748, 749, 750, 751, 752, 753, 754, 755, 756, 757, 758, 759, 760, 761, 762, 763, 764, 765, 766, 767, 768, 769, 770, 771, 772, 773, 774, 775, 776, 777, 778, 779, 780, 781, 782, 783, 784, 785, 786, 787, 788, 789, 790, 791, 792, 793, 794, 795, 796, 797, 798, 799, 800, 801, 802, 803, 804, 805, 806, 807, 808, 809, 810, 811, 812, 813, 814, 815, 816, 817, 818, 819, 820, 821, 822, 823, 824, 825, 826, 827, 828, 829, 830, 831, 832, 833, 834, 835, 836, 837, 838, 839, 840, 841, 842, 843, 844, 845, 846, 847, 848, 849, 850, 851, 852, 853, 854, 855, 856, 857, 858, 859, 860, 861, 862, 863, 864, 865, 866, 867, 868, 869, 870, 871, 872, 873, 874, 875, 876, 877, 878, 879, 880, 881, 882, 883, 884, 885, 886, 887, 888, 889, 890, 891, 892, 893, 894, 895, 896, 897, 898, 899, 900, 901, 902, 903, 904, 905, 906, 907, 908, 909, 910, 911, 912, 913, 914, 915, 916, 917, 918, 919, 920, 921, 922, 923, 924, 925, 926, 927, 928, 929, 930, 931, 932, 933, 934, 935, 936, 937, 938, 939, 940, 941, 942, 943, 944, 945, 946, 947, 948, 949, 950, 951, 952, 953, 954, 955, 956, 957, 958, 959, 960, 961, 962, 963, 964, 965, 966, 967, 968, 969, 970, 971, 972, 973, 974, 975, 976, 977, 978, 979, 980, 981, 982, 983, 984, 985, 986, 987, 988, 989, 990, 991, 992, 993, 994, 995, 996, 997, 998, 999, 1000	SITE PLAN WITH LOCATION OF CERAMIC TILES COMPANY AT BEN QASIM 2007-09	SHABIBR TILES & CERAMICS LTD. NEW PROJECT AT BEN QASIM 2007-09	ISSUE NO. 01 DATE 10/4/16	DRAWN BY: [Name] CHECKED BY: [Name] APPROVED BY: [Name]	PROJECT NO. 100 SHEET NO. 01 DATE 10/4/16
--	---	---	--	------------------------------	---	---

**THANK  
YOU**



**For Contact**

**A.E.A. International (Private) Limited**

Suite # 313, 3<sup>rd</sup> Floor, Anum Estate,

Shahrah-e-Faisal, Karachi-Pakistan.

Tel No. 0092-21-34311985-6

E-mail: [info@aea.agc-green.com](mailto:info@aea.agc-green.com), [rak@agc-green.com](mailto:rak@agc-green.com)

Web Address: [www.agc-green.com](http://www.agc-green.com)